



THOR200-X11EHG2

2U/2 Military GPU Rugged Computer Intel Tiger Lake
i7-11850HE Processor, MIL-STD-461 EMI 18-36V DC-In



User's Manual

Revision Date: April.27. 2023

Safety Information

Electrical safety

- To prevent electrical shock hazard, disconnect the power cable from the electrical outlet before relocating the system.
- When adding or removing devices to or from the system, ensure that the power cables for the devices are unplugged before the signal cables are connected. If possible, disconnect all power cables from the existing system before you add a device.
- Before connecting or removing signal cables from the motherboard, ensure that all power cables are unplugged.
- Seek professional assistance before using an adapter or extension cord. These devices could interrupt the grounding circuit.
- Make sure that your power supply is set to the correct voltage in your area.
- If you are not sure about the voltage of the electrical outlet you are using, contact your local power company.
- If the power supply is broken, do not try to fix it by yourself. Contact a qualified service technician or your local distributor.

Operation safety

- Before installing the motherboard and adding devices on it, carefully read all the manuals that came with the package.
- Before using the product, make sure all cables are correctly connected and the power cables are not damaged. If you detect any damage, contact your dealer immediately.
- To avoid short circuits, keep paper clips, screws, and staples away from connectors, slots, sockets and circuitry.
- Avoid dust, humidity, and temperature extremes. Do not place the product in any area where it may become wet.
- Place the product on a stable surface.
- If you encounter any technical problems with the product, contact your local distributor

Statement

- All rights reserved. No part of this publication may be reproduced in any form or by any means, without prior written permission from the publisher.
- All trademarks are the properties of the respective owners.
- All product specifications are subject to change without prior notice

THOR200-X11EHG2 User's Manual

Revision Date: May. 31. 2023

Revision History

Revision	Date (yyyy/mm/dd)	Changes
Version 1.0	2023/04/12	Initial release
Version 2.0	2023/05/30	

Packing list

- ▶ THOR200-X11EHG2 2U/2 Military GPU Rugged System
- ▶ CD (Driver + Quick Installation Guide)

Ordering information

Model Number	[Description]
THOR200-X11-TX	THOR200-X11-TX Military GPU Rugged Computer with Intel® 11th Gen i7-11850HE, Nvidia RTX A2000, DDR4 64GB, 2 x SATA SSD RAID 0/1 support, HD-SDI, CAN bus, IP65, with MIL-DTL-D38999 Connectors, Operating Temp. -40 to 60°C
THOR200-X11-HML2	THOR200-X11-HML2 Military GPU Rugged Computer with Intel® 11th Gen W-11850MLE, DDR4 64GB, 2 x SATA SSD RAID 0/1 support, Nvidia RTX A2000, IP65, with MIL-DTL-D38999 Connectors, Operating Temp. -40 to 60°C
THO200-D15EG	THOR200-D15EG Military GPU Rugged Computer with Intel® 11th Gen XEON D-1577, DDR4 96GB, 2 x SATA SSD RAID 0/1 support, Nvidia RTX A2000, IP65, with D38999 Connectors, Operating Temp. -40 to 60°C.
THOR200-X11EHG2	THOR200-X11-EHG2 Military GPU Rugged Computer with Intel® 11th Gen i7-11850HE, Nvidia RTX A2000, DDR4 64GB, 2 x SATA SSD RAID 0/1 support, IP65, with MIL-DTL-D38999 Connectors, Operating Temp. -40 to 60°C



If any of the above items is damaged or missing, please contact your local distributor.

Index

1.	CHAPTER 1: PRODUCT INTRODUCTION	5
1-1.	KEY FEATURES	5
2.	CHAPTER 2: JUMPERS AND CONNECTORS LOCATIONS	8
2.1.	D38999 CONNECT PIN DEFINITIONS	8
3.	CHAPTER 3: AMI BIOS UTILITY	12
3.1	STARTING	12
3.2	NAVIGATION KEYS	12
3.3	MAIN MENU	13
3.4	ADVANCED MENU	15
3.4.1	RC ACPI SETTINGS	17
3.4.2	CPU CONFIGURATION	18
3.4.3	POWER & PERFORMANCE	19
3.4.3.1	CPU - POWER MANAGEMENT CONTROL	20
3.4.3.2	GT - POWER MANAGEMENT CONTROL	21
3.4.4	CONFIG TDP CONFIGURATIONS	22
3.4.5	PCH FW CONFIGURATION	23
3.4.5.1	AMT CONFIGURATION	24
3.4.5.2	FIRMWARE UPDATE CONFIGURATION	25
3.4.6	OEM FLAGS SETTINGS	26
3.4.7	INTEL® TIME COORDINATED COMPUTING	27
3.4.8	TRUSTED COMPUTING	29
3.4.9	ACPI SETTINGS	30
3.4.10	EMBEDDED CONTROLLER	31
3.4.10.1	HARDWARE MONITOR	33
3.4.10.2	SERIAL PORT 1 CONFIGURATION	34
3.4.10.3	ACPI REPORT METHOD CONFIGURATION	35
3.4.11	SERIAL PORT CONSOLE REDIRECTION	36
3.4.11.1	COM1 CONSOLE REDIRECTION SETTINGS	37
3.4.11.2	LEGACY CONSOLE REDIRECTION SETTINGS	39
3.4.11.3	CONSOLE REDIRECTION SETTINGS	40
3.4.12	INTEL TXT INFORMATION	42
3.4.13	USB CONFIGURATION	43

THOR200-X11EHG2 User's Manual

Revision Date: May. 31. 2023

3.4.14	NETWORK STACK CONFIGURATION	44
3.4.15	NVME CONFIGURATION	45
3.4.16	SM681GEC AES	46
3.5	CHIPSET SETUP	47
3.5.1	SYSTEM AGENT (SA) CONFIGURATION	48
3.5.1.1	MEMORY CONFIGURATION	49
3.5.1.2	GRAPHICS CONFIGURATION	50
3.5.1.2.1	LCD CONTROL	51
3.5.1.3	VMD CONFIGURATION	52
3.5.1.4	PCI EXPRESS CONFIGURATION	53
3.5.1.4.1	PCI EXPRESS ROOT PORT 1	54
3.5.2	PCH-IO CONFIGURATION	55
3.5.2.1	PCI EXPRESS CONFIGURATION	56
3.5.2.1.1	PCI EXPRESS ROOT PORT 0	57
3.5.2.2	SATA CONFIGURATION	58
3.5.2.3	USB CONFIGURATION	59
3.5.2.4	SECURITY CONFIGURATION	60
3.5.2.5	HD AUDIO SUBSYSTEM CONFIGURATION SETTINGS	61
3.5.2.6	SERIALIo CONFIGURATION	62
3.6	SECURITY CHIPSET	63
3.6.1	SECURE BOOT	64
3.6.2	BOOT SETUP	65
3.7	SAVE & EXIT	66

THOR200-X11EHG2 User's Manual

Revision Date: May. 31. 2023

1. CHAPTER 1: PRODUCT INTRODUCTION

1-1. Key Features

System	
CPU	Intel® 11th Gen. i7-11850HE Processor (24M Cache, Base Frequency 2.6GHz; Max Turbo Frequency 4.7GHz)
Memory Type	2 x DDR4 3200MHz 64GB
Graphics	NVidia® RTX A2000 2560 CUDA® cores, 4GB GDDR6 128-bit
BIOS	AMI® BIOS
Storage Device	2x 2.5" SATAIII SSD (2x Swappable SSD Tray) with RAID 0/1
Front I/O	
DC In	1 x Amphenol TV07RW-09-98P
LAN	1 x Amphenol TV07RW-09-09S
LAN	1 x Amphenol TV07RW-09-09S
GND	1 x GND Screw
Power Button with LED backlight	
Rear I/O	
DVI	1 x Amphenol TV07RW-13-35S
DVI	1 x Amphenol TV07RW-13-35S
USB 3.0	1 x Amphenol USB3FTV7AZNF312
USB 3.0	1 x Amphenol USB3FTV7AZNF312
Applications	
Applications	2U/2 Size Rugged Mission MIL-STD 810 Computer is built to meet strict size, weight, and power (SWaP) requirements and to withstand harsh environments, including temperature extremes, shock/vibe, sand/dust, and salt/fog.
Operation System	
OS Support	Windows 10 64bit, Windows server 2019 64bit, Windows 2016 64bit, Hyper-V Server 2016 R2, Ubuntu 16.04.3 LTS/17.10/18.04.1 LTS, Fedora 25/26, RedHat Linux EL 6.8/6.9/7.3/7.4/7.6, VMware ESXi6.5u1, VMware ESXi6.7u2
Mechanical & Environment	
Chassis	Aluminum Alloy, Corrosion design
Finish	Anodic aluminum oxide
Cooling	Natural Passive Convection/Conduction. No Moving Parts
Ingress Protection	IP65
Power Requirements	MIL-STD-461 EMI Power Supply, 18-36V DC In
Dimension (W x D x H)	220 x 350 x 88mm (8.6" x 13.7" x 3.4")
Operating Temp.	-40 to 60°C
Storage Temp.	-40 to 85°C
Relative Humidity	5% to 95%, non-condensing

THOR200-X11EHG2 User's Manual

Revision Date: May. 31. 2023

1-2. Dimensions(2D)

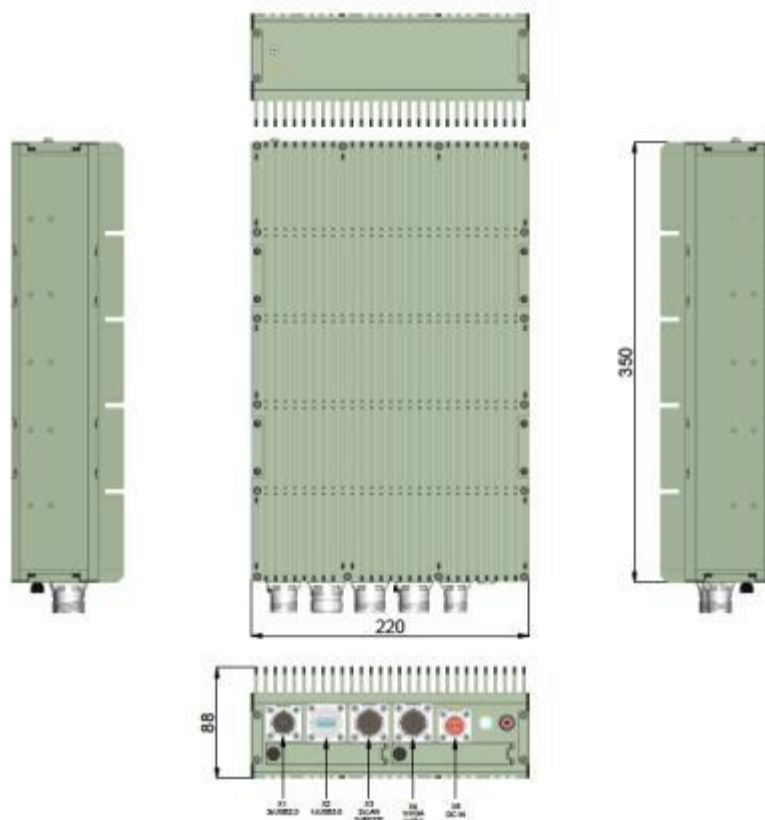

Dimensions(3D)



THOR200-X11EHG2 User's Manual

Revision Date: May. 31. 2023

1-3. Panel Component



1	USB2.0 x 4 label (X1)
2	USB 3.0 label (X2)
3	LAN x2, RS232 x2 label (X3)
4	VGA/DVI label label (X4)
5	DC-In, label
6	Power button, label
7	HDD LED, label
8	GND, label

2. CHAPTER 2: JUMPERS AND CONNECTORS LOCATIONS

2.1. D38999 Connect Pin Definitions

X1: USB2.0 x4

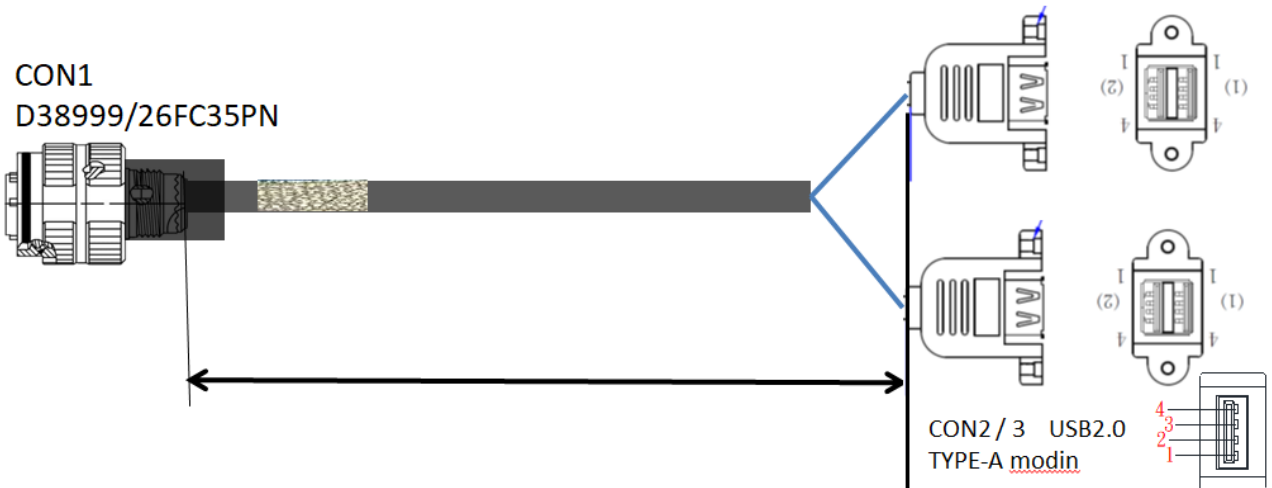

X1	CON1	CON2	CON3	Pin define
1	1	1	Vcc	1
2	2	2	Date-	2
3	3	3	Date+	3
4	4	4	GND	4
5	1	1	Vcc	5
6	2	2	Date-	6
7	3	3	Date+	7
8	4	4	GND	8
9				
10				
11	1	1	Vcc	11
12	2	2	Date-	12
13	3	3	Date+	13
14	4	4	GND	14
15	1	1	Vcc	15
16	2	2	Date-	16
17	3	3	Date+	17
18	4	4	GND	18
19				
20				
21				

THOR200-X11EHG2 User's Manual

Revision Date: May. 31. 2023

X3: LANx2, RS232x2

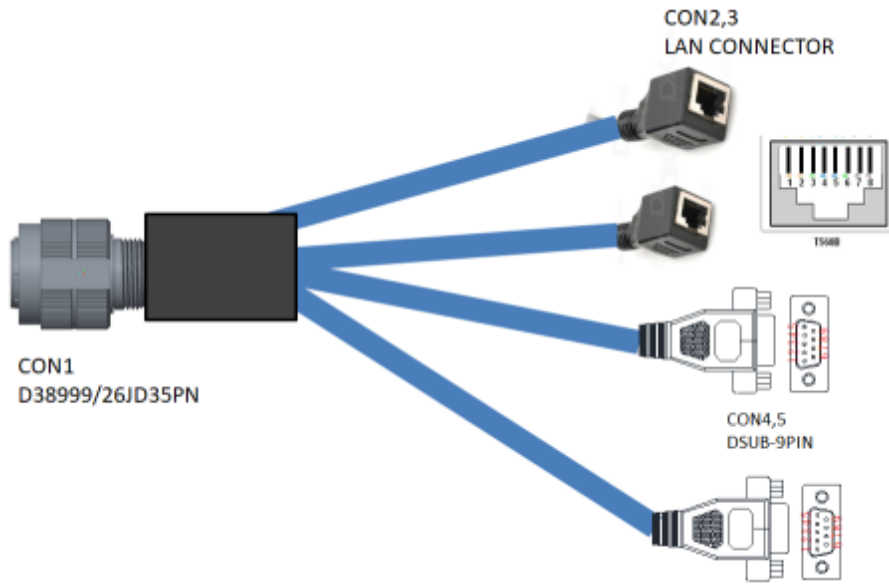

SYSTEM	D38999	Pin define	CON2	CON3	CON4/5
	1	WHITE / ORANGE	1		
	2	ORANG	2		
	3	WHITE / GREEN	3		
	4	GREEN	6		
	5	WHITE / BLUE	5		
	6	BLUE	4		
	7	WHITE / BROWN	7		
	8	BROWN	8		
	9	WHITE / ORANGE		1	
	10	ORANG		2	
	11	WHITE / GREEN		3	
	12	GREEN		6	
	13	WHITE / BLUE		5	
	14	BLUE		4	
	15	WHITE / BROWN		7	
	16	BROWN		8	
	17				
	18				
	19				
	20				
	21	DCD			1
	22	RXD			2
	23	TXD			3
	24	DTR			4
	25	GND			5
	26	DSR			6
	27	RTS			7
	28	CTS			8
	29	DCD			1
	30	RXD			2
	31	TXD			3
	32	DTR			4
	33	GND			5
	34	DSR			6
	35	RTS			7
	36	CTS			8
	37				



THOR200-X11EHG2 User's Manual

Revision Date: May. 31. 2023

X4: VGA/DVIx4

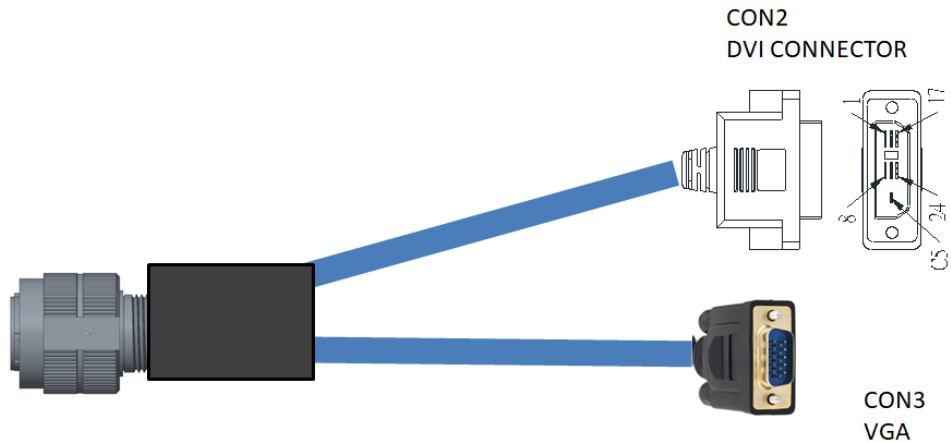

CON1
D38999/26JD35PA

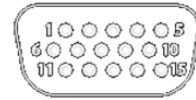

SYSTEM	D38999	Pin define	CON2	CON3
	1	DPA_TN0	1	
	2	DPA_TP0	2	
	3	GND	3	
	4	DPA_AUXP_CLK(p)	23	
	5	DPA_AUXP_CLK(n)	24	
	6	GND	22	
	7	DPA_TN1	9	
	8	DPA_TP1	10	
	9	GND	11	
	10	DPA_PWR	14	
	11	Return GND	15	
	12	DPA_DET	16	
	13	DPA_TN2	17	
	14	DPA_TP2	18	
	15	GND	19	
	16	CLOCK Shield		
	17	DPA_TP3	6	
	18	DPA_TN3	7	
	19	GND	shell	
	20			
	21	VS		14
	22	SCL		15
	23	HS		13
	24	SDA		12
	25	GND		10/5
	26	PWR		9
	27	RED		1
	28	BLUE		3
	29	GREEN		2
	30			
	31			
	32			
	33			
	34			
	35			
	36			
	37			



THOR200-X11EHG2 User's Manual

Revision Date: May. 31. 2023

X5: DC-IN

CON1
D38999/26MB2SN



		Pin define	D38999	
Y 端 Power DC-IN		TN1	(+)	A
		TN2	(-)	B



CHAPTER 3: AMI BIOS UTILITY

This chapter provides users with detailed descriptions on how to set up a basic system configuration through the AMI BIOS setup utility.

3.1 STARTING

To enter the setup screens, perform the following steps:

- Turn on the computer and press the key immediately.
- After the key is pressed, the main BIOS setup menu displays. Other setup screens can be accessed from the main BIOS setup menu, such as the Chipset and Power menus.

3.2 NAVIGATION KEYS

The BIOS setup/utility uses a key-based navigation system called hot keys. Most of the BIOS setup utility hot keys can be used at any time during the setup navigation process. Some of the hot keys are <F1>, <F10>, <Enter>, <ESC>, and <Arrow> keys.



Some of the navigation keys may differ from one screen to another.

Left/Right	The Left and Right <Arrow> keys moves the cursor to select a menu.
Up/Down	The Up and Down <Arrow> keys moves the cursor to select a setup screen or sub-screen.
+– Plus/Minus	The Plus and Minus <Arrow> keys changes the field value of a particular setup setting.
Tab	The <Tab> key selects the setup fields.
F1	The <F1> key displays the General Help screen.
F10	The <F10> key saves any changes made and exits the BIOS setup utility.
Esc	The <Esc> key discards any changes made and exits the BIOS setup utility.
Enter	The <Enter> key displays a sub-screen or changes a selected or highlighted option in each menu.

3.3 MAIN MENU

The Main menu is the screen that first displays when BIOS Setup is entered, unless an error has occurred.

When you first enter the BIOS Setup Utility, you will encounter the Main setup screen. You can always return to the Main setup screen by selecting the Main tab. There are two Main Setup options. They are described in this section. The Main BIOS Setup screen is shown below.

The Main BIOS setup screen has two main frames. The left frame displays all the options that can be configured. Grayed-out options cannot be configured; options in blue can. The right frame displays the key legend. Above the key legend is an area reserved for a text message. When an option is selected in the left frame, it is highlighted in white. Often a text message will accompany it.



- **System Date**

Use this function to change the system date.

Select System Date using the Up and Down <Arrow> keys. Enter the new values through the keyboard. Press the Left and Right <Arrow> keys to move between fields.

The date setting must be entered in MM/DD/YY format.

- **System Time**

Use this function to change the system time.

Select System Time using the Up and Down <Arrow> keys. Enter the new values through

THOR200-X11EHG2 User's Manual

Revision Date: May. 31. 2023

the keyboard. Press the Left and Right <Arrow> keys to move between idles.

The time setting is entered in HH:MM:SS format.

Note: The time is in 24-hour format. For example, 5:30 A.M. appears as 05:30:00, and 5:30 P.M. as 17:30:00.

3.4 ADVANCED MENU

The Advanced Menu allows you to configure your system for basic operation. Some entries are defaults required by the system board, while others, if enabled, will improve the performance of your system or let you set some features according to your preference. **Setting incorrect field**

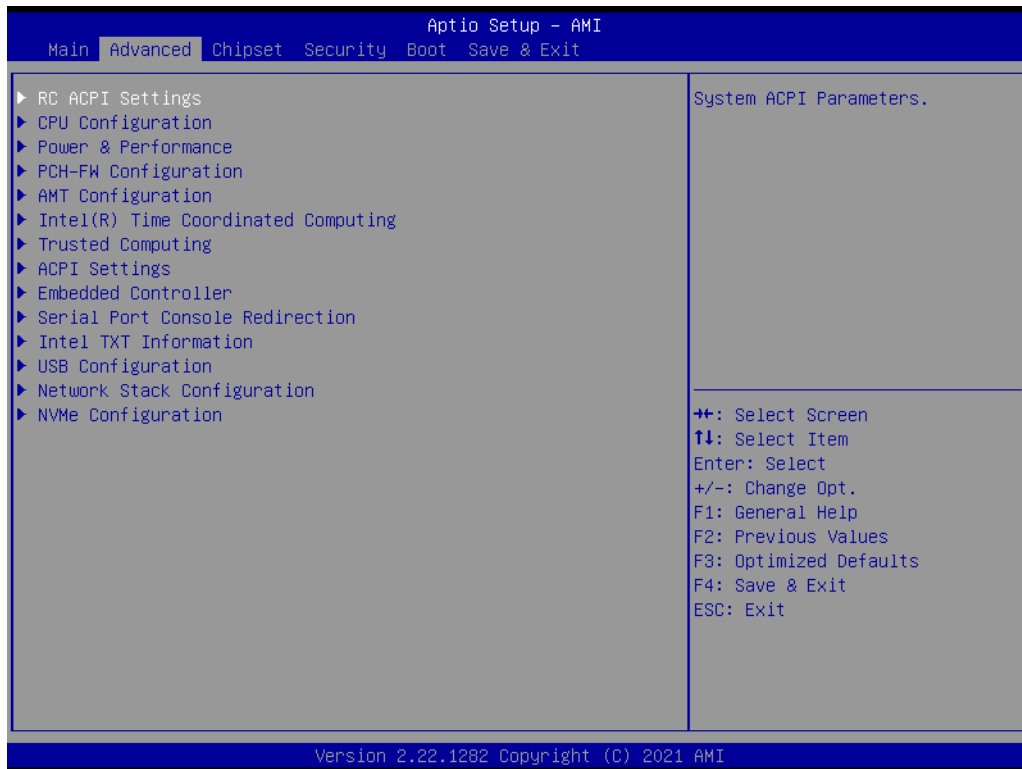

values may cause the system to malfunction.

Figure 3.3 Advanced BIOS Features Setup Screen

- RC ACPI Settings**
System ACPI Parameters.
- CPU Configuration**
CPU Configuration Parameters.
- Power & Performance**
Power & Performance Options.
- PCH-FW Configuration**
Configure Management Engine Technology Parameters.
- AMT Configuration**
Configure Intel(R) Active Management Technology Parameters.
- Intel(R) Time Coordinated Computing**
Intel(R) Time Coordinated Computing (Intel(R) TCC) options.

- Trusted Computing**
Trusted Computing Settings.
- ACPI Settings**
ACPI Sleep State.
- Embedded Controller**
Embedded Controller Parameters.
- Serial Port Console Redirection**
Console Redirection Settings.

- Intel TXT Information**
Display Intel TXT information.
- USB Configuration**
USB Configuration Parameters.
- Network Stack Configuration**
Network Stack Settings.
- NVMe Configuration**
NVMe controller and Drive information.

3.4.1 RC ACPI SETTINGS



Figure 3.4 RC ACPI Settings

□ Low Power S0 Idle Capability

This variable determines if we enable ACPI Lower Power S0 Idle Capability (Mutually exclusive with Smart connect). While this is enabled, it also disable 8254 timer for SLP_S0 support.

3.4.2 CPU CONFIGURATION

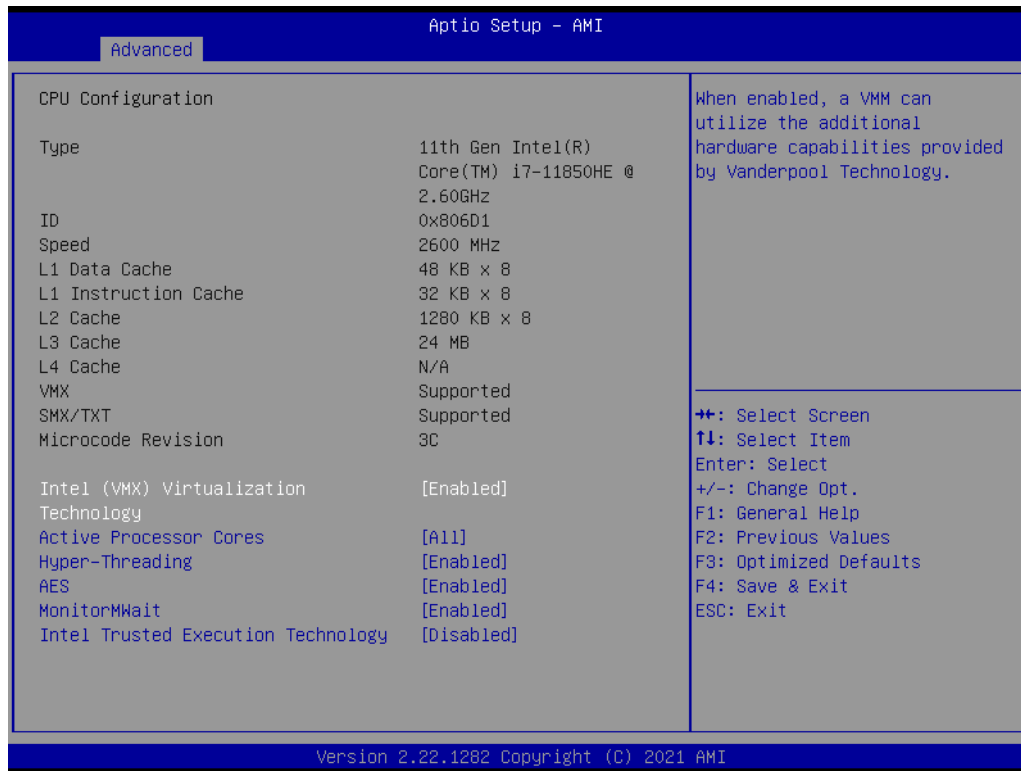

Figure 3.5 CPU Configuration

- Intel (VMX) Virtualization Technology**
When enabled, a VMM can utilize the additional hardware capabilities provided by Vanderpool Technology.
- Active Processor Cores**
Number of cores to enable in each processor package.
- Hyper-Threading**
Enable or Disable Hyper-Threading Technology.
- AES**
Enable/Disable AES (Advanced Encryption Standard).
- MonitorMwait**
Enable/Disable Monitor Mwait.
- Intel Trusted Execution Technology**
Enables utilization of additional hardware capabilities provided by Intel (R) Trusted Execution Technology.

3.4.3 POWER & PERFORMANCE



Figure 3.6 Power & Performance

- CPU - Power Management Control**
CPU - Power Management Control Options.
- GT - Power Management Control**
GT - Power Management Control Options.

3.4.3.1 CPU - POWER MANAGEMENT CONTROL

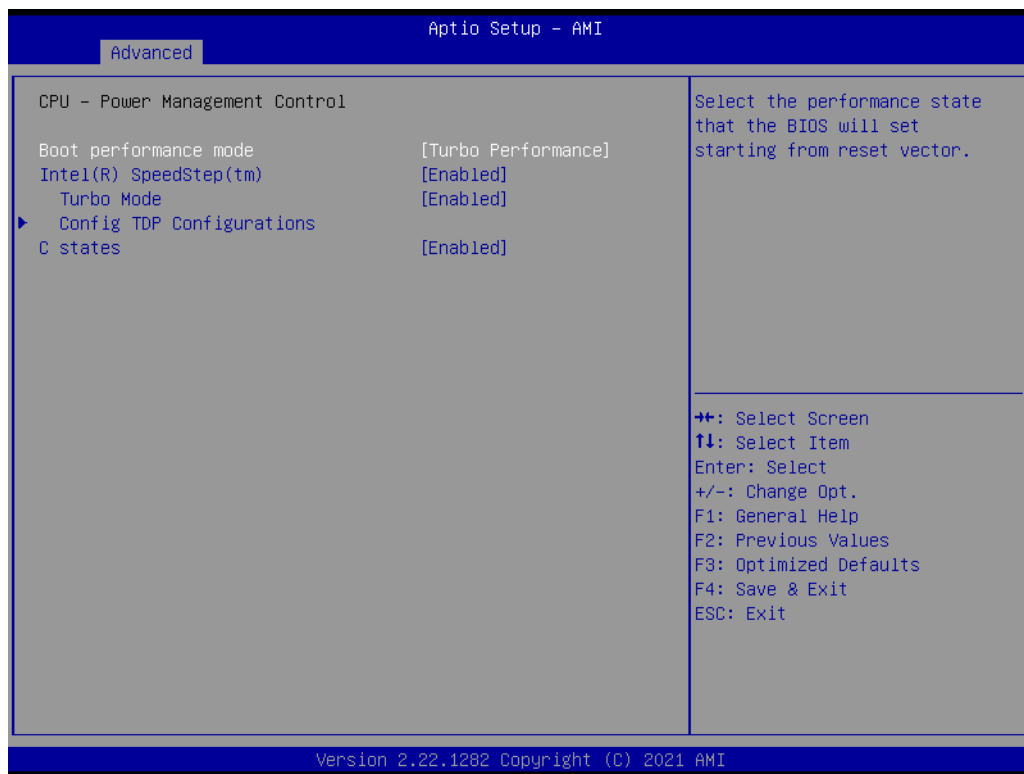

Figure 3.7 Power & Performance

- Boot performance mode**
Select the performance state that the BIOS will set starting from reset vector.
- Intel(R) SpeedStep(tm)**
Allows more than two frequency ranges to be supported.
- Turbo Mode**
Enable/Disable processor Turbo Mode (requires EMTTM enabled too). AUTO means enabled.
- Config TDP Configurations**
Config TDP Configurations.
- C states**
Enable/Disable CPU Power Management. Allows CPU to go to C states when it's not 100% utilized.

3.4.3.2 GT – POWER MANAGEMENT CONTROL



Figure 3.9 GT - Power Management Control

- RC6 (Render Standby)**
Check to enable render standby support.

3.4.4 CONFIG TDP CONFIGURATIONS

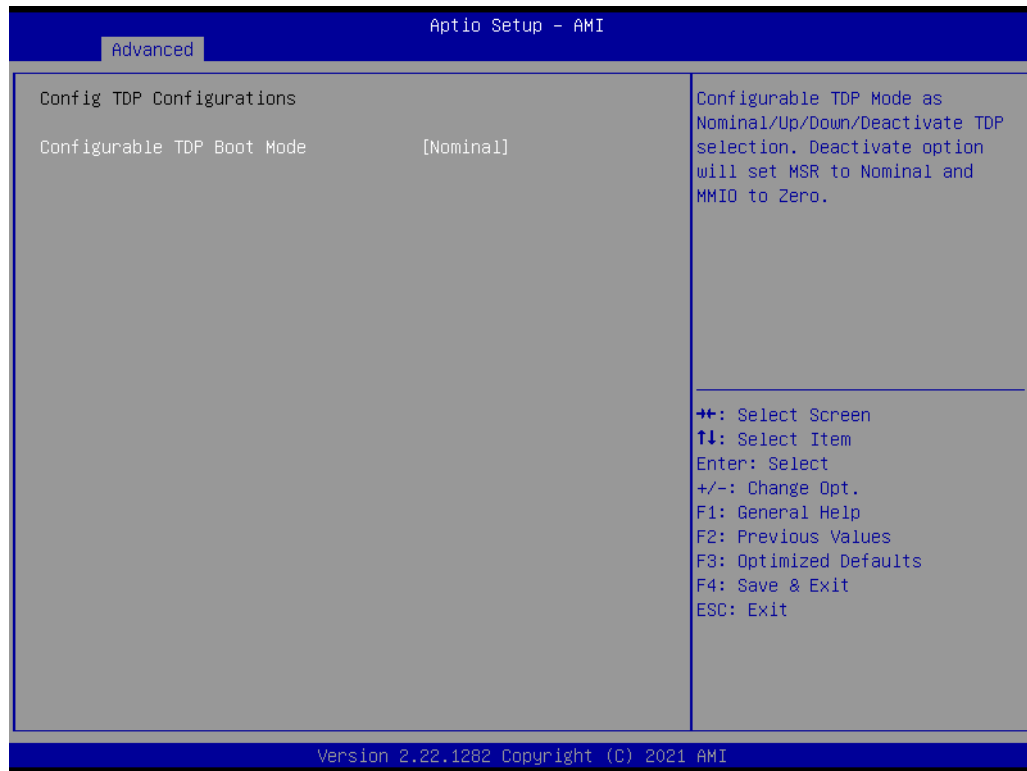

Figure 3.8 Config TDP Configurations

□ Configurable TDP Boot Mode

Configurable TDP Mode as Nominal/Up/Down/Deactivate TDP selection. Deactivate option will set MSR to Nominal and MMIO to Zero

3.4.5 PCH FW CONFIGURATION

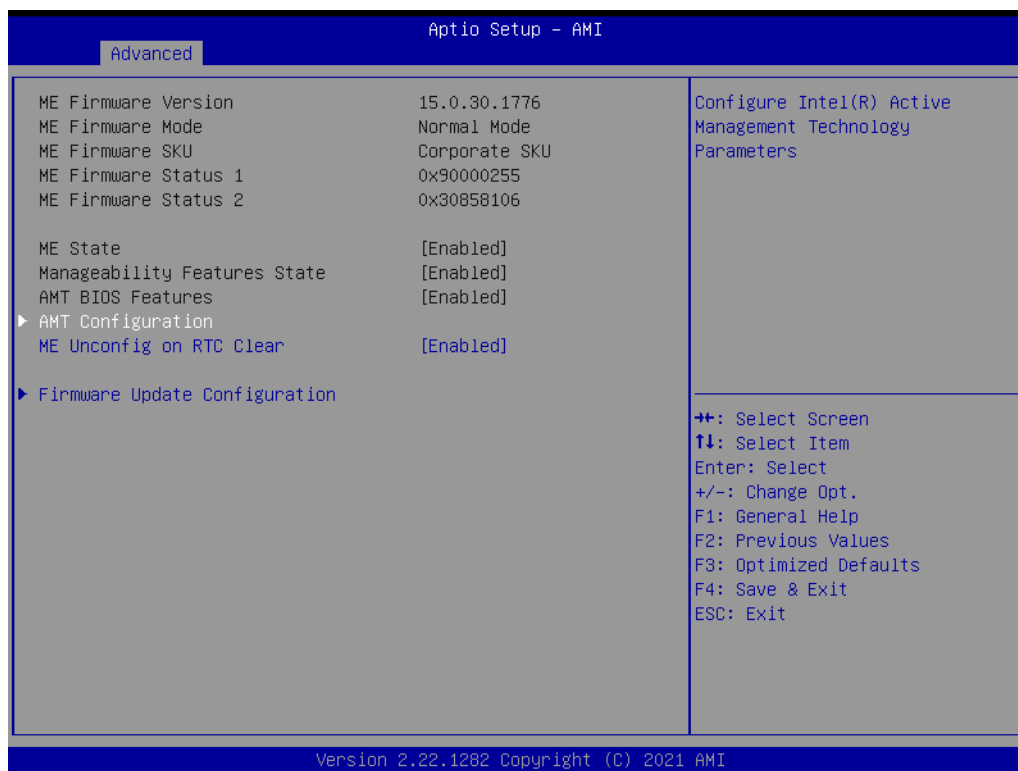

Figure 3.10 PCH-FW Configuration

- AMT Configuration**
Configure Intel(R) Active Management Technology Parameters.
- ME Unconfig on RTC Clear**
When Disabled ME will not be unconfigured on RTC clear.
- Firmware Update Configuration**
Configure Management Engine Technology Parameters.

3.4.5.1 AMT CONFIGURATION

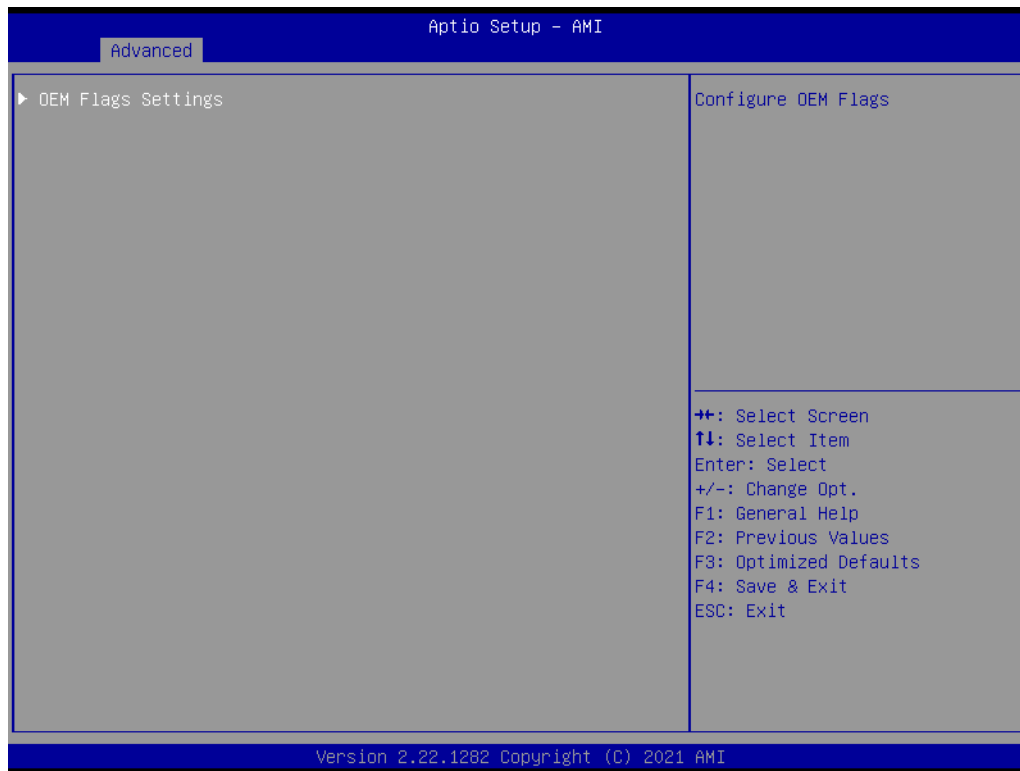

Figure 3.11 AMT Configuration

- **OEM Flags Settings**
Configure OEM Flags.

3.4.5.2 FIRMWARE UPDATE CONFIGURATION

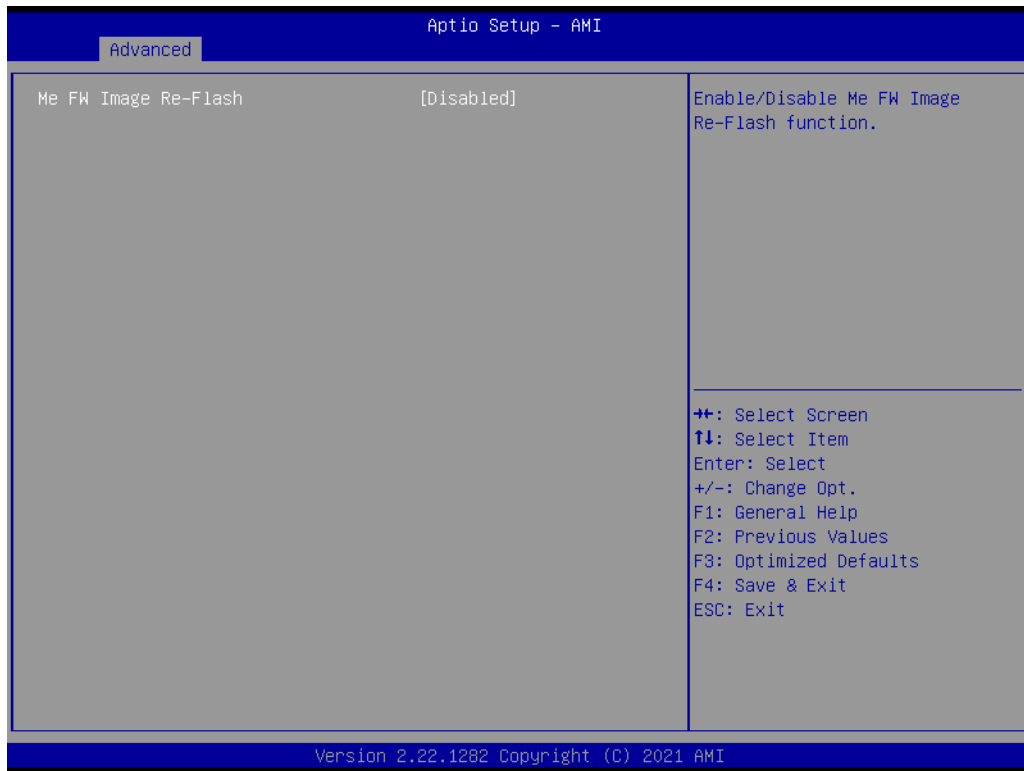

Figure 3.12 OEM Flags Settings

- Me FW Image Re-Flash**
Enable/Disable Me FW Image Re-Flash function

3.4.6 OEM FLAGS SETTINGS

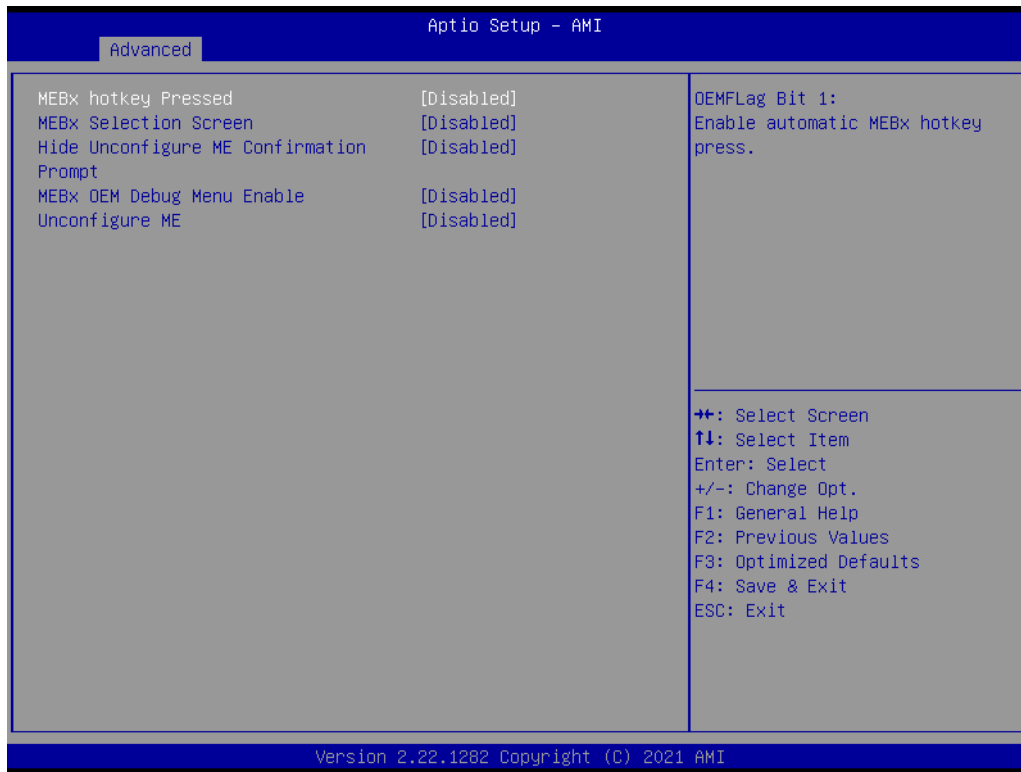

Figure 3.12 OEM Flags Settings

- MEBx hotkey Pressed**
OEMFlag Bit 1: Enable automatic MEBx hotkey press.
- MEBx Selection Screen**
OEMFlag Bit 2: Enable MEBx selection screen with 2 options: Press 1 to enter ME Configuration Screens.
Press 2 to initiate a remote connection.
Note: Network Access must be activated from MEBx Setup for this screen to be displayed.
- Hide Unconfigure ME Confirmation Prompt**
OEMFlag Bit 6: Hide Unconfigure ME confirmation prompt when attempting ME unconfiguration.
- MEBx OEM Debug Menu Enable**
OEMFlag Bit 14: Enable OEM debug menu in MEBx.
- Unconfigure ME**
OEMFlag Bit 15: Unconfigure ME with resetting MEBx password to default.

3.4.7 INTEL® TIME COORDINATED COMPUTING

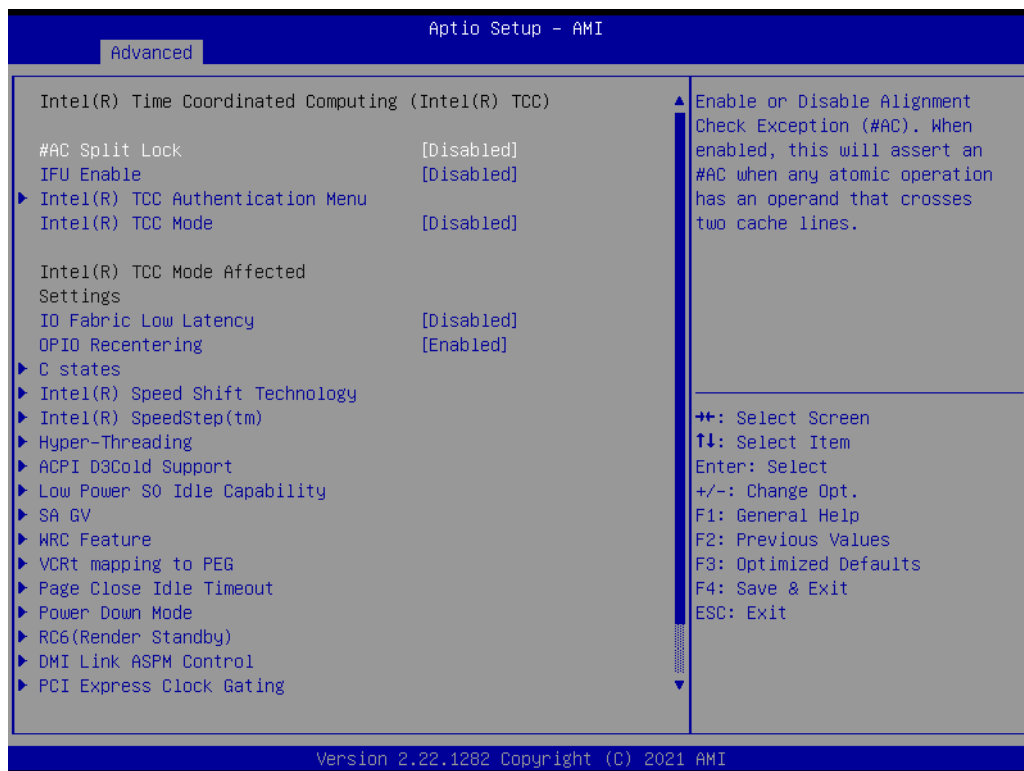

Figure 3.14 Intel® Time Coordinated Computing

- ❑ **#AC Split Lock**
Enable or Disable Alignment Check Exception (#AC). When enabled, this will assert an #AC when any atomic operation has an operand that crosses two cache lines.
- ❑ **IFU Enable**
Enable or Disable Instruction Fetch Unit(IFU). When enabled, Instructions will be prefetch to the cache.
- ❑ **Intel® TCC Authentication Menu**
Intel® TCC Authentication Menu options.
- ❑ **Intel® TCC Mode**
Enable or Disable Intel® TCC Mode. When enabled, this will modify system settings to improve real-time performance. The full list of settings and their current state are displayed below when Intel® TCC mode is enabled.
- ❑ **IO Fabric Low Latency**
Enable or Disable IO Fabric Low Latency. This will turn off some power management in the PCH IO fabrics. This option provides the most aggressive IO Fabric performance setting. S3 state is NOT supported.

- OPIO Recentering**
Enable or Disable Opio Recentering to improve Pcie latency.
- C states**
Enable/Disable CPU Power Management. Allows CPU to go to C states when it's not 100% utilized.
- Intel® Speed Shift Technology**
Enable/Disable Intel® Speed Shift Technology support. Enabling will expose the CPPC v2 interface to allow for hardware controlled P-states.
- Intel(R) SpeedStep(tm)**
- Allows more than two frequency ranges to be supported.**
- Hyper-Threading**
- Enable or Disable Hyper-Threading Technology.**
- ACPI D3Cold Support**
- Enable/Disable ACPI D3Cold(RTD3) Support.**
- Low power S0 Idle Capability**
- This variable determines if we enable ACPI lower power S0 idle capability (Mutually exclusive with smart connect) While this is enabled, it also disable 8254 timer for SLP_S0 support.**
- SA GV**
- System agent geyserville. Can disable, fix to a specific point, or enable frequency switching.**
- Page Close Idle Timeout**
- Page close idle timeout control.**
- Power Down Mode**
- CKE Power Down Mode Control.**
- RC6(Render standby)**
- Check to enable render standby support.**
- DMI Link ASPM Control**
- The control of Active State Power Management of the DMI Link.**
- PCI Express Clock Gating**
- PCI Express Clock Gating Enable/Disable for each root port.**
- Legacy IO Low Latency**
- Set to enable low latency of legacy IO. Some systems require lower IO latency irrespective of power. This is a tradeoff between power and IO latency.**
- CPU PCI Express Configuration**
- PCH PCI Express Configuration**

3.4.8 TRUSTED COMPUTING



Figure 3.15 Trusted Computing

- SHA256 PCR Bank**
Enable or Disable SHA256 PCR Bank.
- Pending operation**
Pending operation.
- Platform Hierarchy**
Enable or Disable Platform Hierarchy.
- Storage Hierarchy**
Enable or Disable Storage Hierarchy.
- Endorsement Hierarchy**
Enable or Disable Endorsement Hierarchy.
- Physical Presence Spec Version**
Select to Tell O.S. to support PPI Spec Version 1.2 or 1.3. Note some HCK tests might not support 1.3.
- Device Select**
TPM 1.2 will restrict support to TPM 1.2 devices, TPM 2.0 will restrict support to TPM 2.0 devices, Auto will support both with the default set to TPM 2.0 devices if not found, TPM 1.2 devices will be enumerated.
- Disable Block Sid**
Override to allow SID authentication in TCG Storage device.

3.4.9 ACPI SETTINGS

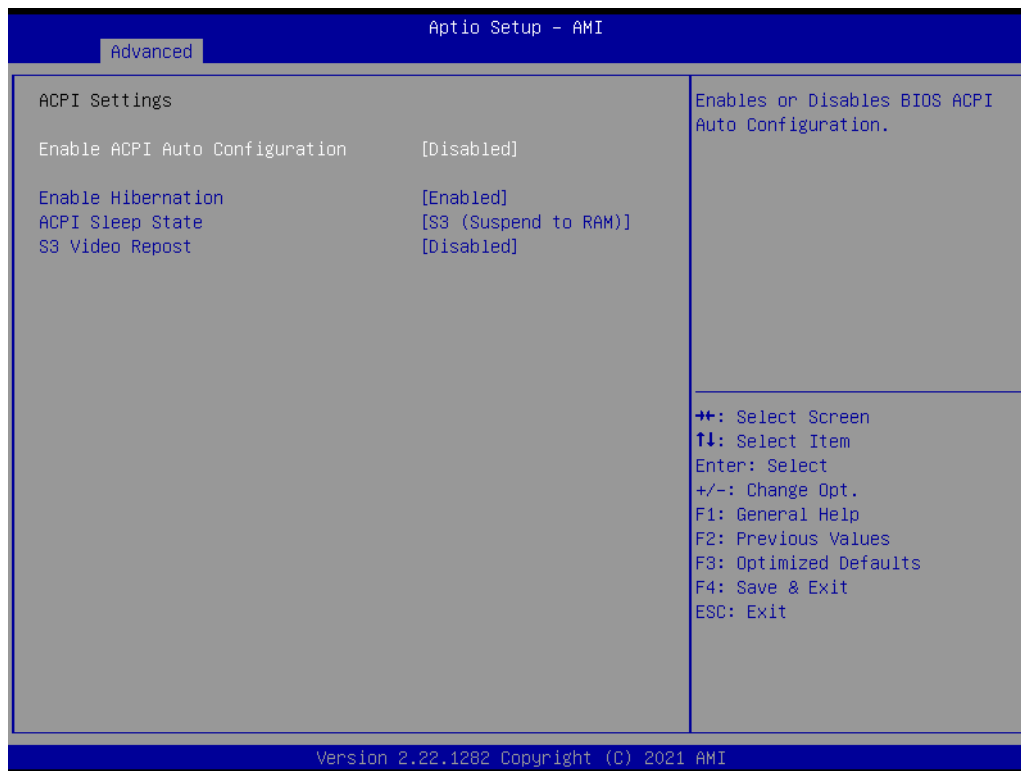

Figure 3.16 ACPI Settings

- Enable ACPI Auto Configuration**
Enables or Disables BIOS ACPI Auto Configuration.
- Enable Hibernation**
Enables or Disables System ability to Hibernate (OS/S4 Sleep State). This option may be not effective with some OS.
- ACPI Sleep State**
Select the highest ACPI sleep state the system will enter when the SUSPEND button is pressed.
- S3 Video Repost**
Enable or Disable S3 Video Repost.

3.4.10 EMBEDDED CONTROLLER

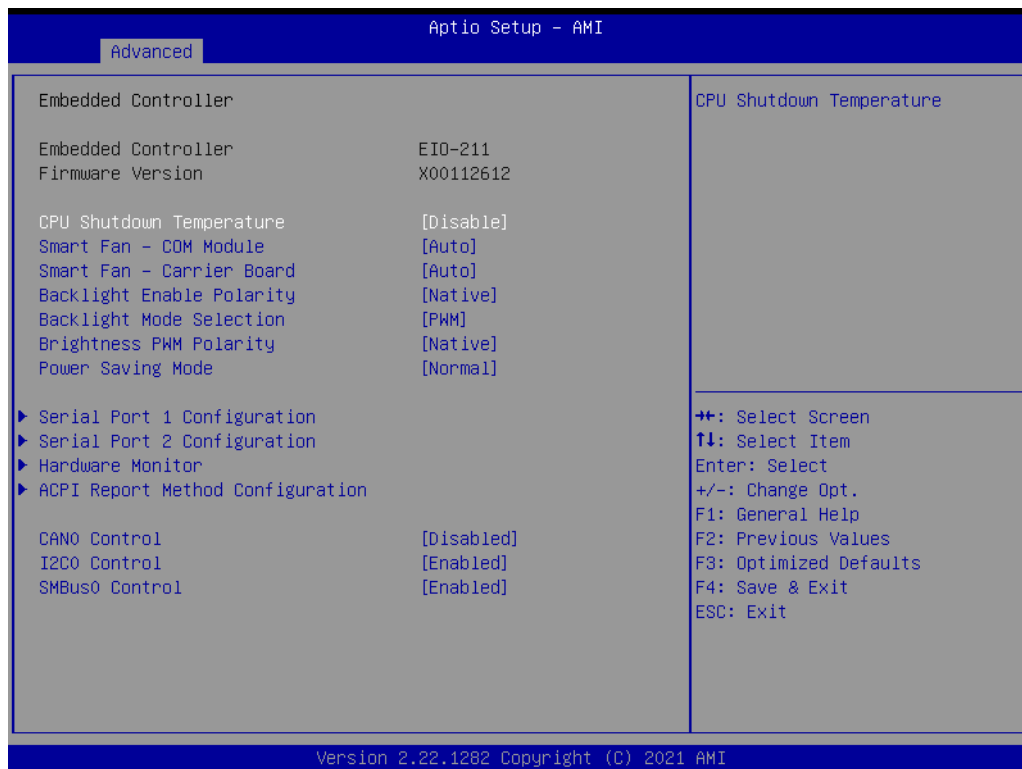

Figure 3.17 Embedded Controller

- CPU Shutdown Temperature**
CPU Shutdown Temperature.
- Smart Fan - COM Module**
Control COM Module Smart FAN function.
- Smart Fan - Carrier Board**
Control Carrier Board Smart FAN function. Get value from EC and only set value when Save Changes.
- Backlight Enable Polarity**
Switch Backlight Enable Polarity for Native or Invert.
- Backlight Mode Selection**
Switch Backlight Control to PWM or DC mode.
- Brightness PWM Polarity**
Backlight Control Brightness PWM Polarity for Native or Invert.
- Power Saving Mode**
Select Power Saving Mode.
- Serial Port 1 Configuration**
Set Parameters of Serial Port 1 (COMA).

- Serial Port 2 Configuration**
Set Parameters of Serial Port 2 (COMB).
- Hardware Monitor**
Monitor hardware status.
- ACPI Report Method Configuration**
Select ACPI Reporting Method for EC Devices.
- CAN0 Control**
Enable/Disable CAN0 controller on RDC-IS200.
- I2C0 Control**
Enable/Disable I2C0 controller on RDC-IS200.
- SMBus0 Control**
Enable/Disable SMBus0 controller on RDC-IS200

3.4.10.1 HARDWARE MONITOR

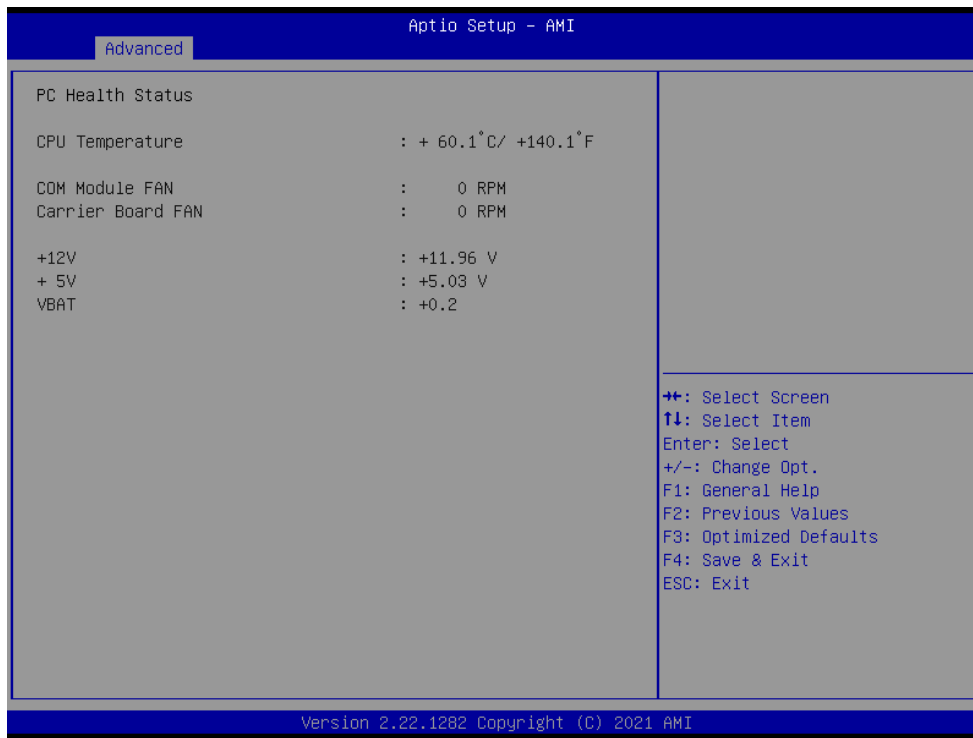

Figure 3.18 Hardware Monitor

3.4.10.2 SERIAL PORT 1 CONFIGURATION



Figure 3.19 Serial Port 1 Configuration

- Serial Port**
Enable or Disable Serial Port (COM).
- Change Settings**
Select an optimal settings for Super IO Device.

3.4.10.3 ACPI REPORT METHOD CONFIGURATION

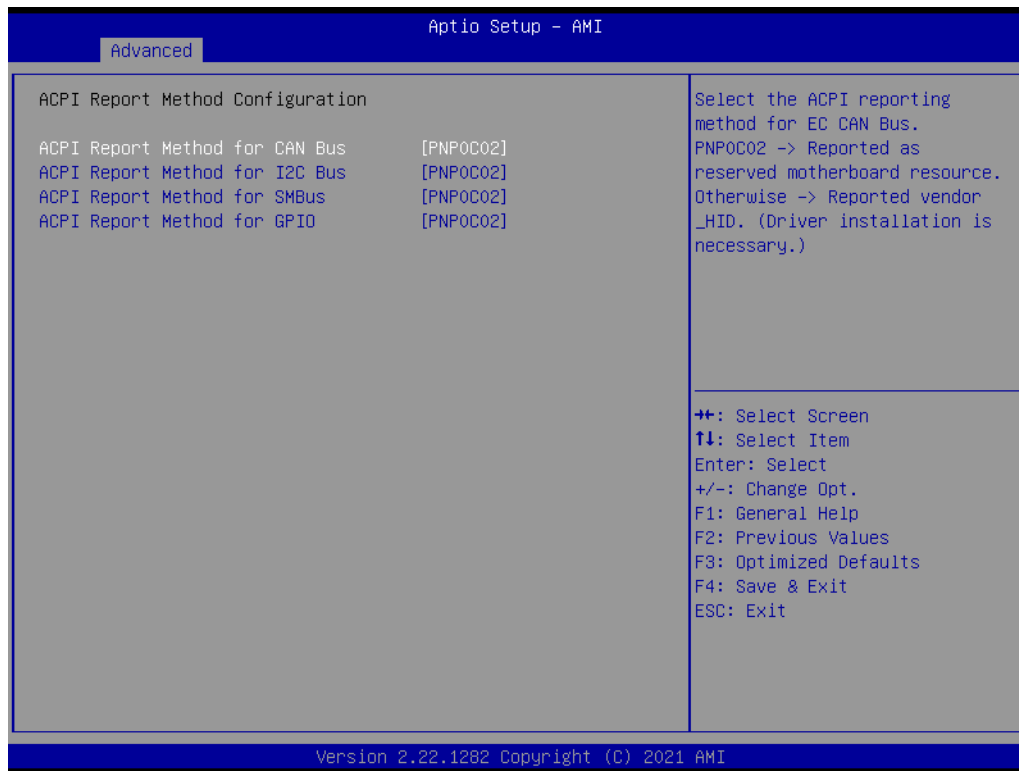

Figure 3.20 ACPI Report Method Configuration

- ❑ **CPI Report Method for CAN Bus**
Select the ACPI reporting method for EC CAN Bus. PNP0C02 -> Reported as reserved motherboard resource.
Otherwise -> Reported vendor _HID. (Driver installation is necessary.)
- ❑ **ACPI Report Method for I2C Bus**
Select the ACPI reporting method for EC I2C Bus. PNP0C02 -> Reported as reserved motherboard resource.
Otherwise -> Reported vendor _HID. (Driver installation is necessary.)
- ❑ **ACPI Report Method for SMBus**
Select the ACPI reporting method for EC SMBus. PNP0C02 -> Reported as reserved motherboard resource.
Otherwise -> Reported vendor _HID. (Driver installation is necessary.)
- ❑ **ACPI Report Method for GPIO**
Select the ACPI reporting method for EC GPIO.
PNP0C02 -> Reported as reserved motherboard resource.
Otherwise -> Reported vendor _HID. (Driver installation is necessary.)

3.4.11 SERIAL PORT CONSOLE REDIRECTION

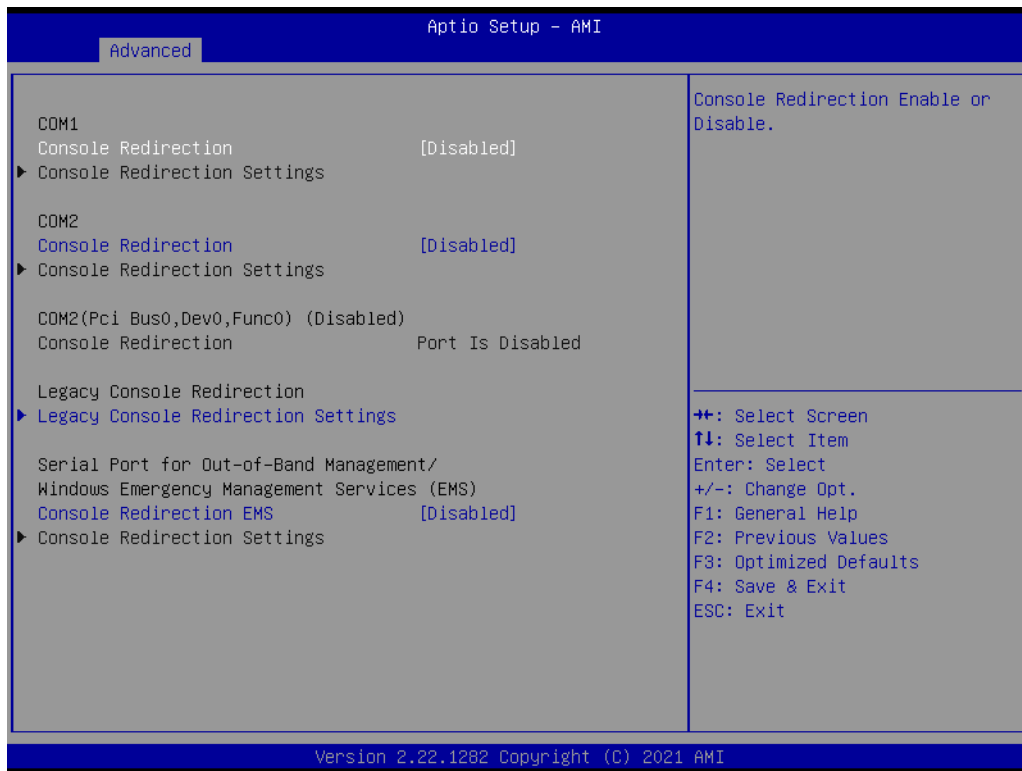

Figure 3.21 Serial Port Console Redirection

- ❑ **COM1 Console Redirection**
Console Redirection Enable or Disable.
- ❑ **Console Redirection Settings**
The settings specify how the host computer and the remote computer (which the user is using) will exchange data. Both computers should have the same or compatible settings.
- ❑ **COM2 Console Redirection**
Console Redirection Enable or Disable.
- ❑ **Console Redirection Settings**
The settings specify how the host computer and the remote computer (which the user is using) will exchange data. Both computers should have the same or compatible settings.
- ❑ **Legacy Console Redirection**
Legacy Console Redirection Settings.
- ❑ **Console Redirection EMS**
Console Redirection Enable or Disable.
- ❑ **Console Redirection Settings**
The settings specify how the host computer and the remote computer (which the user is using) will exchange data. Both computers should have the same or compatible settings.

3.4.11.1 COM1 CONSOLE REDIRECTION SETTINGS

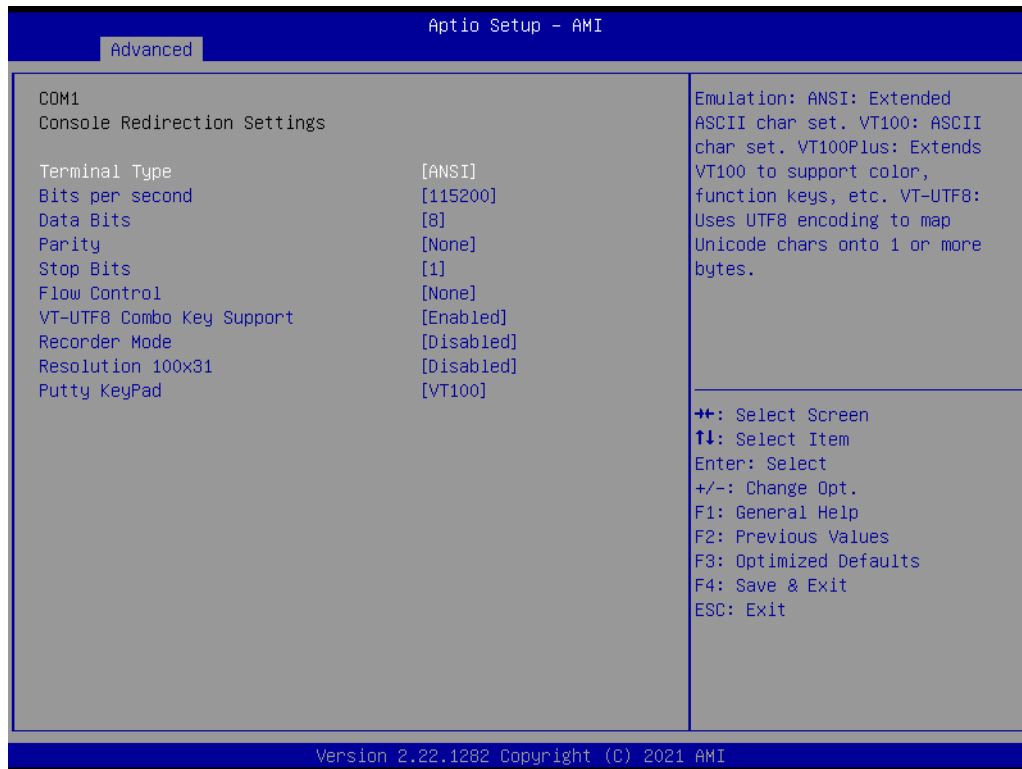

Figure 3.22 COM1 Console Redirection Settings

- ❑ **Terminal Type**
Emulation: ANSI: Extended ASCII char set. VT100: ASCII char set. VT100Plus: Extends VT100 to support color, function keys, etc. VT-UTF8: Uses UTF8 encoding to map Unicode chars onto 1 or more bytes.
- ❑ **Bits per second**
Selects serial port transmission speed. The speed must be matched on the other side. Long or noisy lines may require lower speeds.
- ❑ **Data Bits**
Data Bits.
- ❑ **Parity**
A parity bit can be sent with the data bits to detect some transmission errors. Even: parity bit is 0 if the num of 1's in the data bits is even. Odd: parity bit is 0 if num of 1's in the data bits is odd. Mark: parity bit is always 1. Space: Parity bit is always 0. Mark and Space Parity do not allow for error detection. They can be used as an additional data bit.
- ❑ **Stop Bits**
Stop bits indicate the end of a serial data packet. (A start bit indicates the beginning). The standard setting is 1 stop bit. Communication with slow devices may require more

than 1 stop bit.

Flow Control

Flow control can prevent data loss from buffer overflow. When sending data, if the receiving buffers are full, a 'stop' signal can be sent to stop the data flow. Once the buffers are empty, a 'start' signal can be sent to re-start the flow. Hardware flow control uses two wires to send start/stop signals.

VT-UTF8 Combo Key Support

Enable VT-UTF8 Combination Key Support for ANSI/VT100 terminals.

Recorder Mode

With this mode enabled only text will be sent. This is to capture Terminal data.

Resolution 100x31

Enables or disables extended terminal resolution.

Putty KeyPad

Select FunctionKey and KeyPad on Putty.

3.4.11.2 LEGACY CONSOLE REDIRECTION SETTINGS



Figure 3.23 Legacy Console Redirection Settings

- Redirection COM Port**
Select a COM port to display redirection of Legacy OS and Legacy OPROM Messages.
- Resolution**
On Legacy OS, the Number of Rows and Columns supported redirection.
- Redirect After POST**
When Bootloader is selected, then Legacy Console Redirection is disabled before booting to legacy OS. When Always Enable is selected, then Legacy Console Redirection is enabled for legacy OS. Default setting for this option is set to Always Enable

3.4.11.3 CONSOLE REDIRECTION SETTINGS



Figure 3.24 Console Redirection Settings

- ❑ **Out-of-Band Mgmt Port**

Microsoft Windows Emergency Management Services (EMS) allows for remote management of a Windows Server OS through a serial port.
- ❑ **Terminal Type**

VT-UTF8 is the preferred terminal type for out-of-band management. The next best choice is VT100+ and then VT100. See above, in Console Redirection Settings page, for more Help with Terminal Type/Emulation.
- ❑ **Bits per second**

Selects serial port transmission speed. The speed must be matched on the other side. Long or noisy lines may require lower speeds.
- ❑ **Flow Control EMS**

Flow control can prevent data loss from buffer overflow. When sending data, if the receiving buffers are full, a 'stop' signal can be sent to stop the data flow. Once the buffers are empty, a 'start' signal can be sent to re-start the flow. Hardware flow control uses two wires to send start/stop signals.
- ❑ **Data Bits EMS**
- ❑ **Parity**

A parity bit can be sent with the data bits to detect some transmission errors. Even: parity bit is 0 if the num of 1's in the data bits is even. Odd: parity bit is 0 if num of 1's in the data bits is odd. Mark: parity bit is always 1. Space: Parity bit is always 0. Mark and Space Parity do not allow for error detection. They can be used as an additional data bit.

□ **Stop Bits EMS**

Stop bits indicate the end of a serial data packet. (A start bit indicates the beginning). The standard setting is 1 stop bit. Communication with slow devices may require more than 1 stop bit.

3.4.12 INTEL TXT INFORMATION

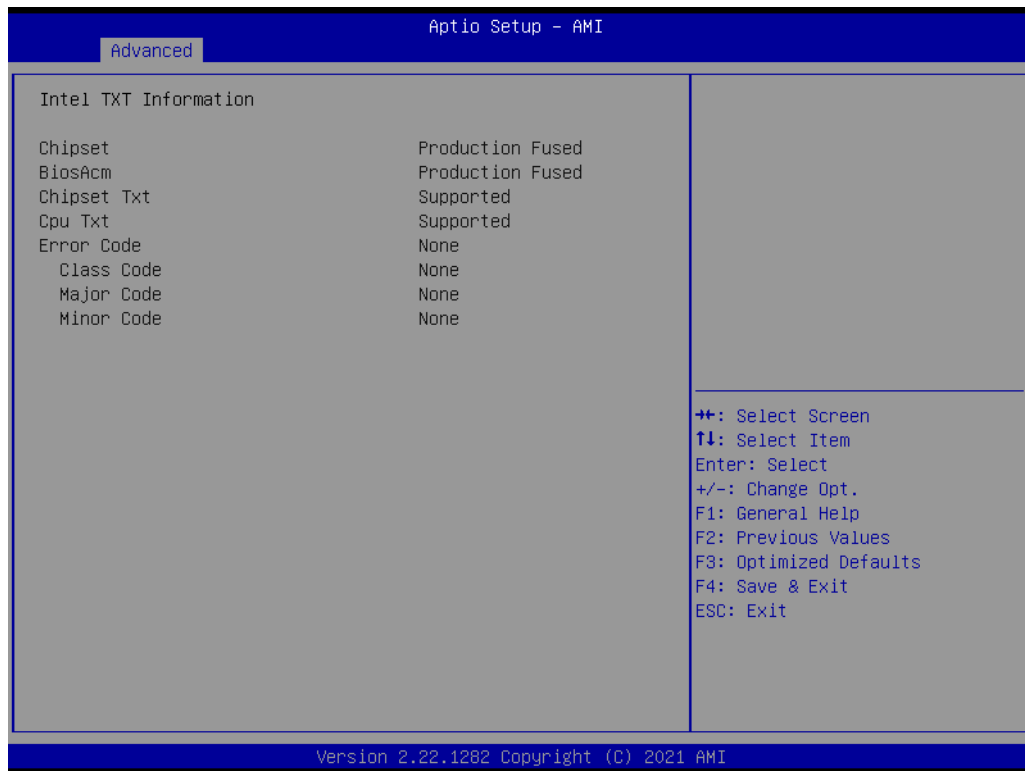

Figure 3.25 Intel TXT Information

3.4.13 USB CONFIGURATION



Figure 3.26 USB Configuration

- Legacy USB Support**
Enables Legacy USB support. AUTO option disables legacy support if no USB devices are connected. DISABLE option will keep USB devices available only for EFI applications.
- XHCI Hand-off**
This is a workaround for OS without XHCI hand-off support. The XHCI ownership change should be claimed by XHCI driver.
- USB Mass Storage Driver Support**
Enable/Disable USB Mass Storage Driver Support.
- USB transfer time-out**
The time-out value for Control, Bulk, and Interrupt transfers.
- Device reset time-out**
USB mass storage device Start Unit command time-out.
- Device power-up delay**
Maximum time the device will take before it properly reports itself to the Host Controller. 'Auto' uses default value: for a Root port it is 100 ms, for a Hub port the delay is taken from Hub descriptor.
- GH PicoBoost PMAP**

3.4.14 NETWORK STACK CONFIGURATION



Figure 3.27 Network Stack Configuration

- Network Stack**
Enable/Disable UEFI Network Stack.
- IPv4 PXE support**
Enable/Disable IPv4 PXE boot support. If disabled, IPv4 PXE boot support will not be available.
- IPv4 HTTP Support**
Enable/Disable IPv4 HTTP boot support. If disabled, IPv4 HTTP boot support will not be available.
- IPv6 PXE Support**
Enable/Disable IPv6 PXE boot support. If disabled, IPv6 PXE boot support will not be available.
- IPv6 HTTP Support**
Enable/Disable IPv6 HTTP boot support. If disabled, IPv6 HTTP boot support will not be available.
- PXE boot wait time**
Wait time in seconds to press ESC key to abort the PXE boot. Use either +/- or numeric keys to set the value.
- Media detect count**
Number of times presence of media will be checked. Use either +/- or numeric keys to set the value.

3.4.15 NVME CONFIGURATION

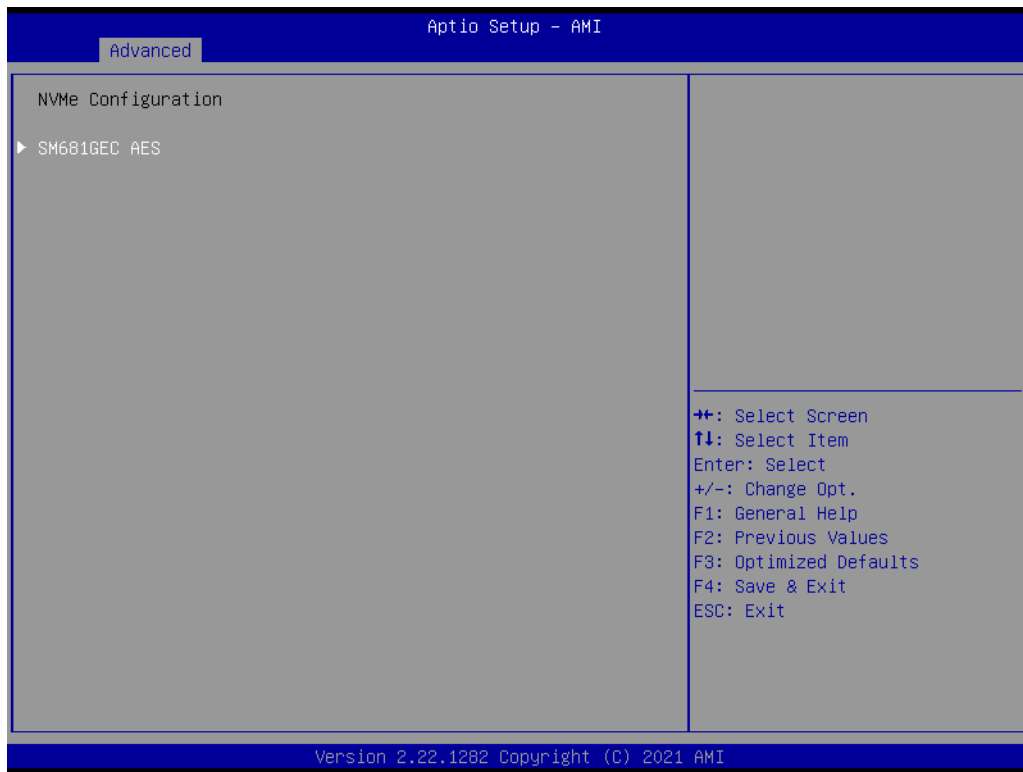

Figure 3.28 NVME Configuration

- SM681GEC AES (Note: This is optional component.)

3.4.16 SM681GEC AES

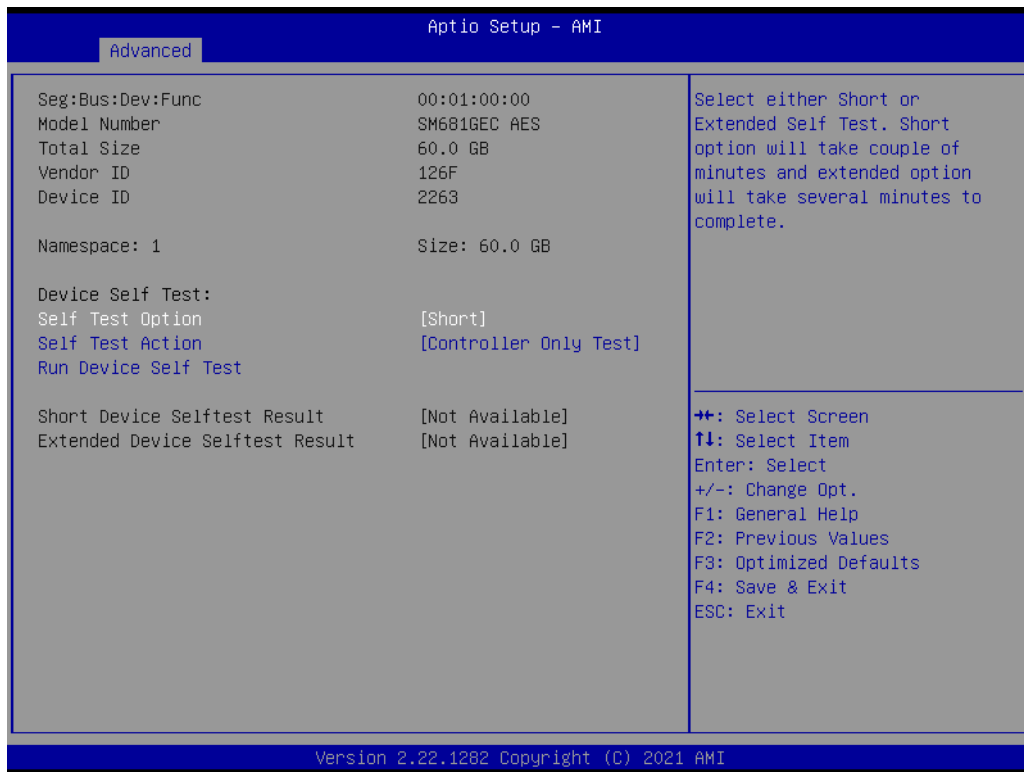

Figure 3.29 SM681GEC AES

- ❑ **Self Test Option**
Select either Short or Extended Self Test. Short option will take couple of minutes and extended option will take several minutes to complete.
- ❑ **Self Test Action**
Select either to test Controller alone or Controller and NameSpace. Selecting Controller and NameSpace option will take lot longer to complete the test.
- ❑ **Run Device Self Test**
Perform device self test for the corresponding Option and Action selected by user. Pressing 'Esc' key will abort the test. Result shown below is the recent result logged in the device.

3.5 CHIPSET SETUP



Figure 3.30 Chipset Setup

- System Agent (SA) Configuration**
System Agent Parameters.
- PCH-I/O Configuration**
PCH parameters.

3.5.1 SYSTEM AGENT (SA) CONFIGURATION

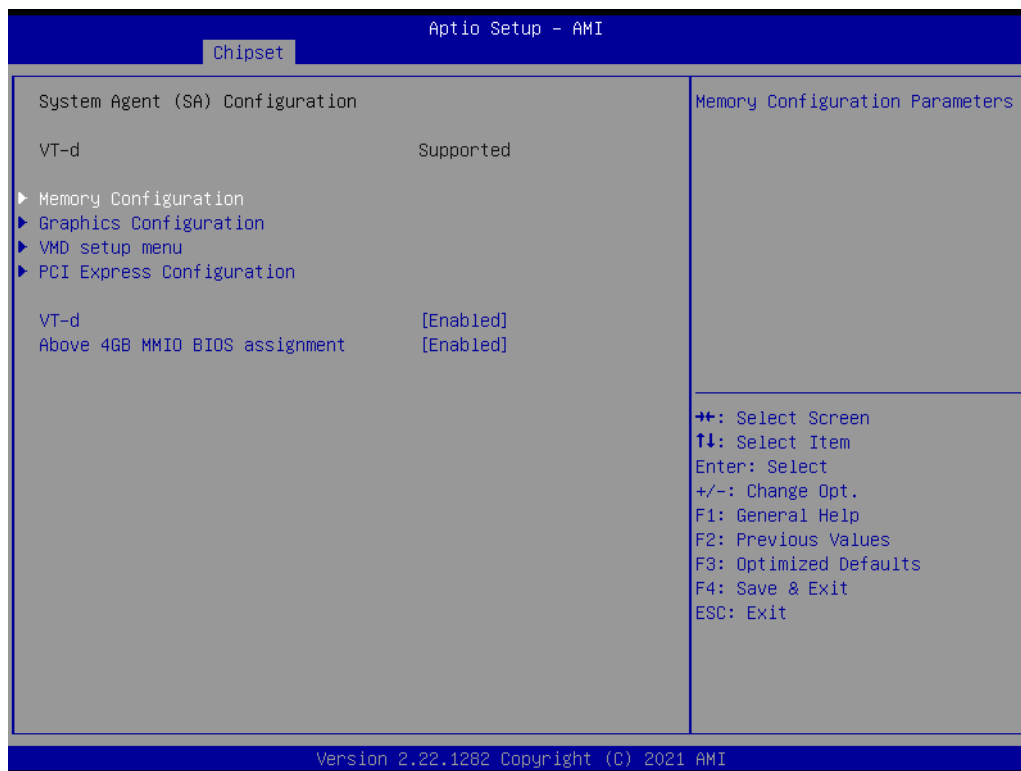

Figure 3.31 System Agent (SA) Configuration

- Memory Configuration**
Memory Configuration Parameters.
- Graphic Configuration**
- VMD setup menu**
VMD Configuration.
- VT-d**
VT-d capability.
- Above 4GB MMIO BIOS assignment**
Enable/Disable above 4GB memory mapped IO BIOS assignment. This is enabled automatically when aperture size is set to 2048MB.

3.5.1.1 MEMORY CONFIGURATION

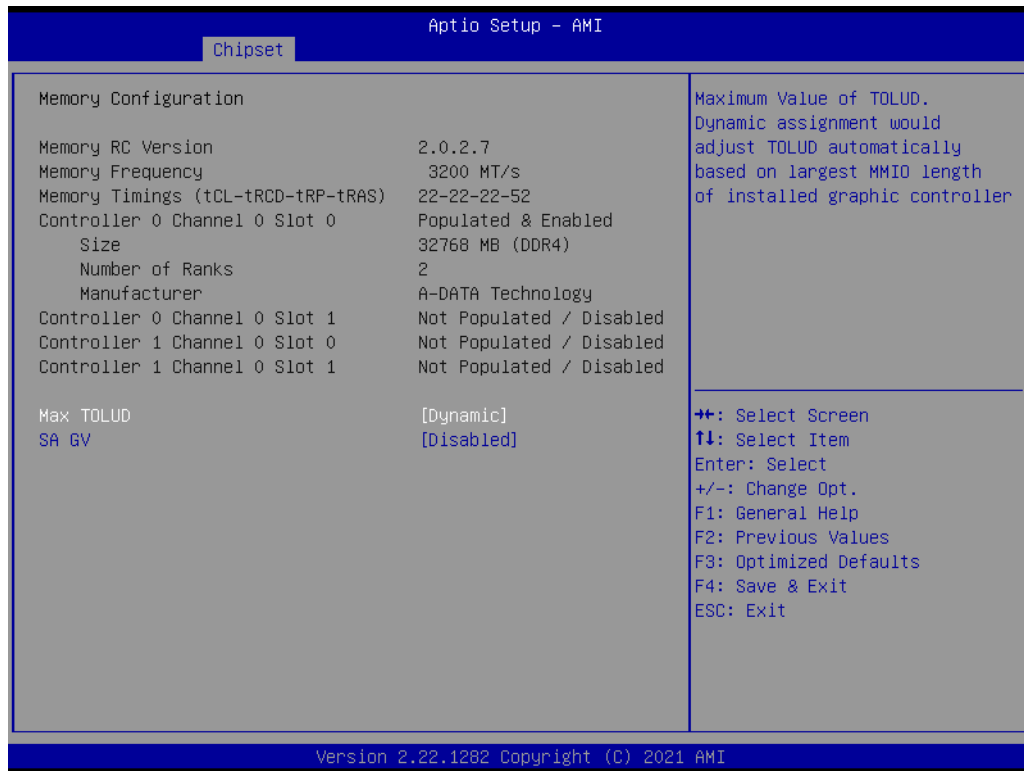

Figure 3.32 Memory Configuration

- ❑ **Max TOLUD**
Maximum value of TOLUD. Dynamic assignment would adjust TOLUD automatically based on the largest MMIO length of installed graphic controller.
- ❑ **SA GV**
System Agent Geyserville. Can disable, fix to a specific point, or enable frequency switching.

3.5.1.2 GRAPHICS CONFIGURATION

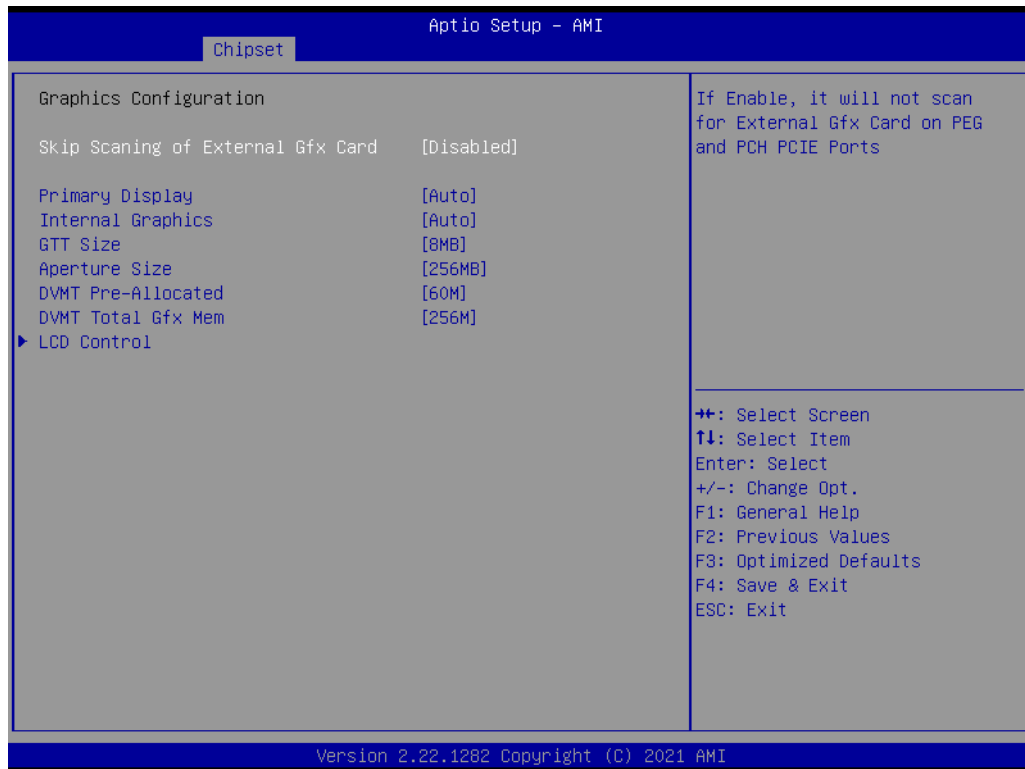

Figure 3.33 Graphics Configuration

- Skip Scanning of External Gfx Card**
If Enable, it will not scan for External Gfx Card on PEG and PCH PCIE Ports.
- Primary Display**
Select which of IGFX/PEG/PCI Graphics device should be Primary Display Or select HG for Hybrid Gfx.
- Internal Graphics**
Keep IGFX enabled base on the setup options.
- GTT Size**
Select the GTT size.
- Aperture Size**
Select the aperture size. Note: Above 4GB MMIO BIOS assignment is atomically enabled when selecting 2048MB aperture. To use this feature, please disable CSM support.
- DVMT Pre-Allocated**
Select DVMT5.0 pre-allocated(fixed) Graphics Memory size is used by the internal graphics device.
- DVMT Total Gfx Mem**
Select DVMT5.0 total graphic memory size is used by the internal graphic device.
- LCD Control**

3.5.1.2.1 LCD CONTROL

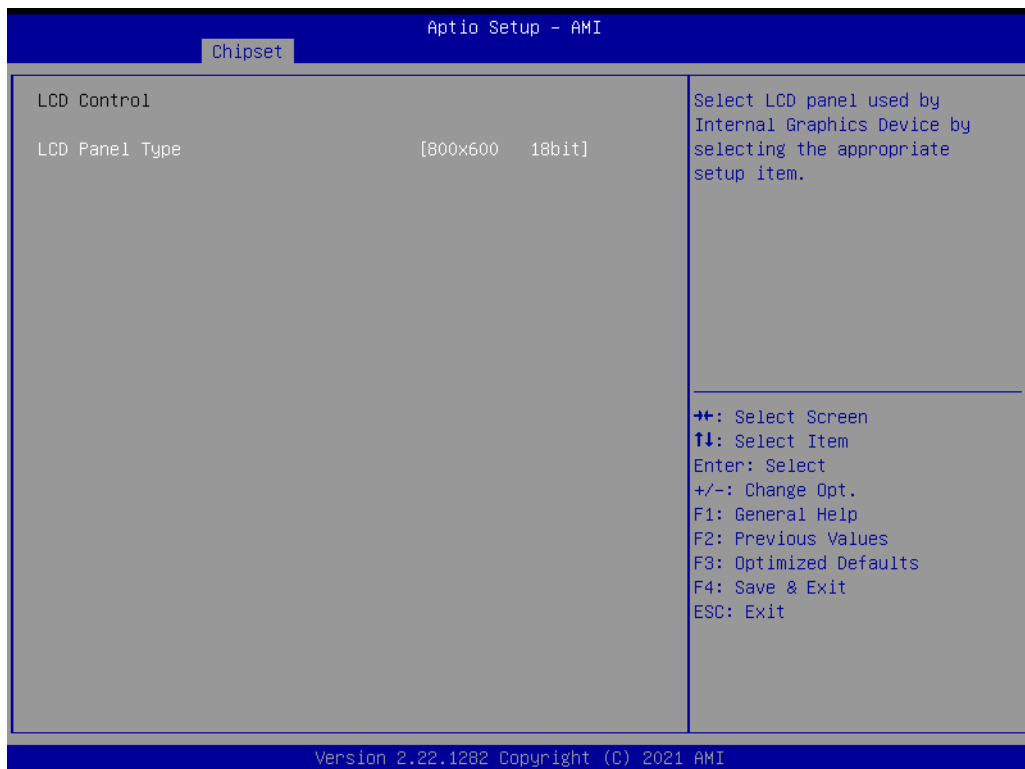

Figure 3.34 LCD Control

- ❑ **LCD Panel Type**
Select LCD panel used by Internal Graphics Device by selecting the appropriate setup item.

3.5.1.3 VMD CONFIGURATION

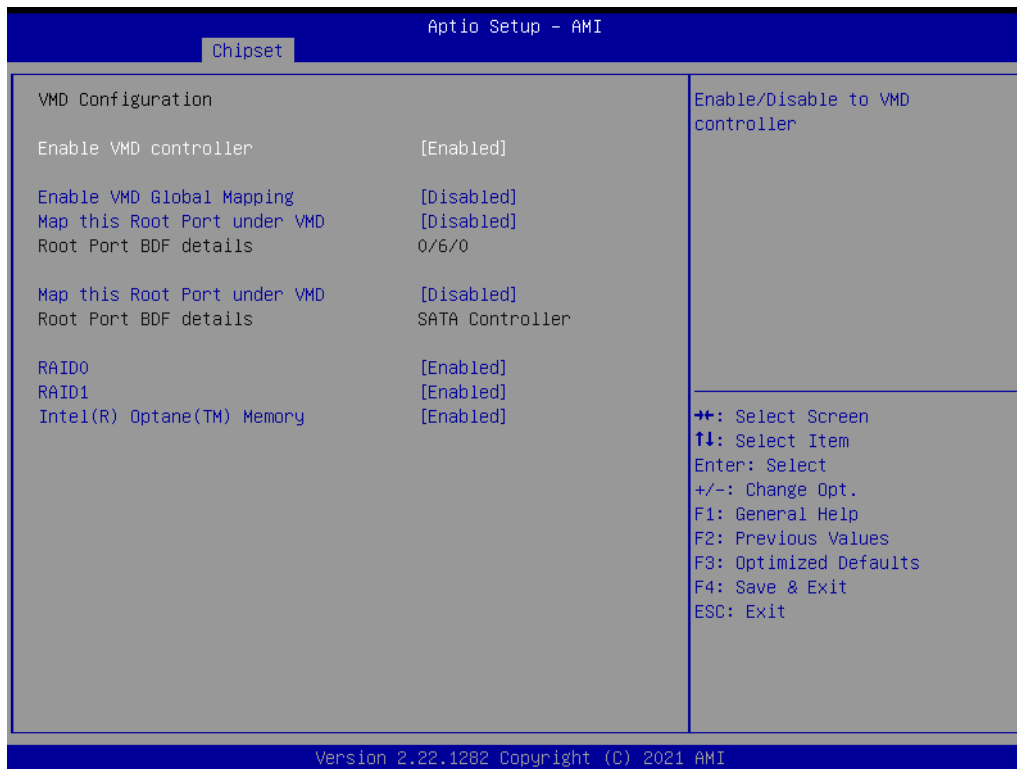

Figure 3.35 VMD Setup Menu

- Enable VMD controller**
Enable/Disable to VMD controller.
- Enable VMD Global Mapping**
Enable/Disable to VMD Global Mapping.
- Map this Root Port under VMD**
- RAID0**
Enable/Disable RAID0 feature.
- RAID1**
Enable/Disable RAID1 feature.
- Intel(R) Optane(TM) Memory**
Enable/Disable System Acceleration with Intel(R) Optane(TM) Memory feature.

3.5.1.4 PCI EXPRESS CONFIGURATION

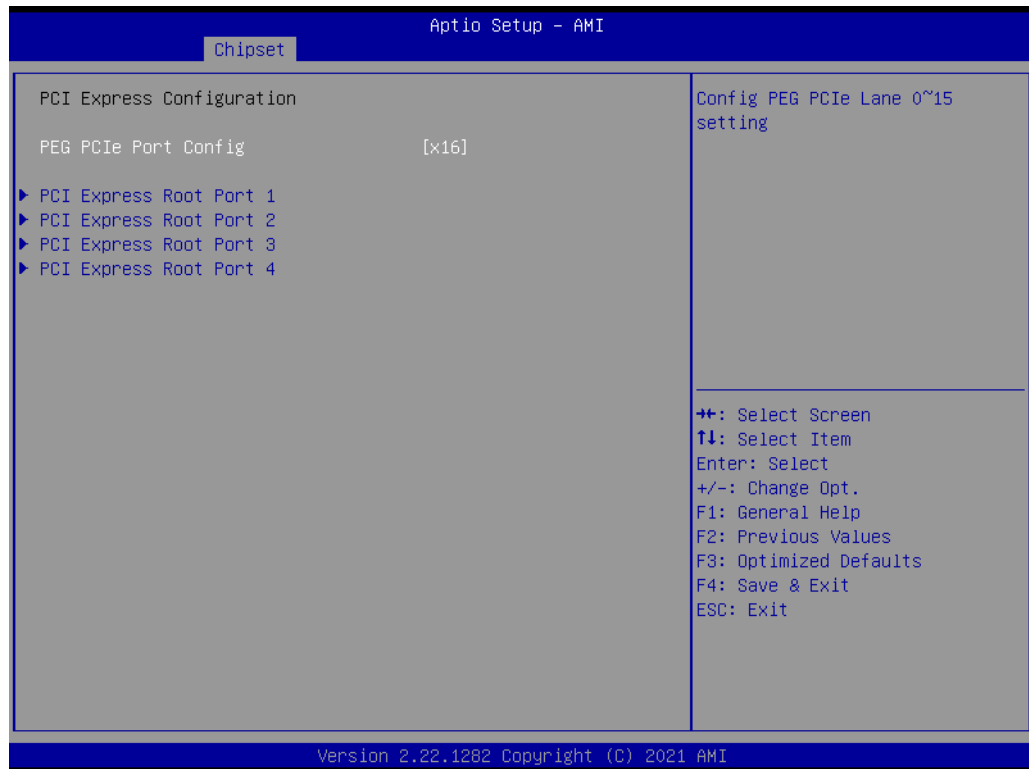

Figure 3.36 PCI Express Configuration

- PEG PCIe Port Config**
Config PEG PCIe Lane 0~15 setting.
- PCI Express Root Port 1**
- PCI Express Root Port 2**
- PCI Express Root Port 3**
- PCI Express Root Port 4**

3.5.1.4.1 PCI EXPRESS ROOT PORT 1



Figure 3.37 PCI Express Root Port 1

- PCI Express Root Port 1**
Control the PCI Express Root Port.
- Connection Type**
Built-In: a built-in device is connected to this root port. Slot Implemented bit will be clear.
Slot: this root port connects to user-accessible slot. Slot Implemented bit will be set.
- ASPM**
PCI Express Active State Power Management settings.
- Hot Plug**
PCI Express Hot Plug Enable/Disable.
- PCIe Speed**
Configure PCIe Speed.

3.5.2 PCH-IO CONFIGURATION



Figure 3.38 PCH-IO Configuration

- PCI Express Configuration**
PCI Express Configuration settings.
- SATA Configuration**
SATA device option settings.
- USB Configuration**
USB Configuration settings.
- Security Configuration**
Security Configuration settings.
- HD Audio Configuration**
HD audio subsystem configuration settings.
- SerialIo Configuration**
SerialIo configuration settings.
- State After G3**
Specify what state to go to when power is re-applied after a power failure (G3 state).
- Pcie Ref P11 SSC**
Pcie Ref P11 SSC Percentatge. AUTO - Keep hw default, no BIOS override. Range is 0.0%-0.5%.
- SPD Write Disable**
Enable/Disable setting SPD Write Disable. For security recommendations, SPD write disable bit must be set

3.5.2.1 PCI EXPRESS CONFIGURATION

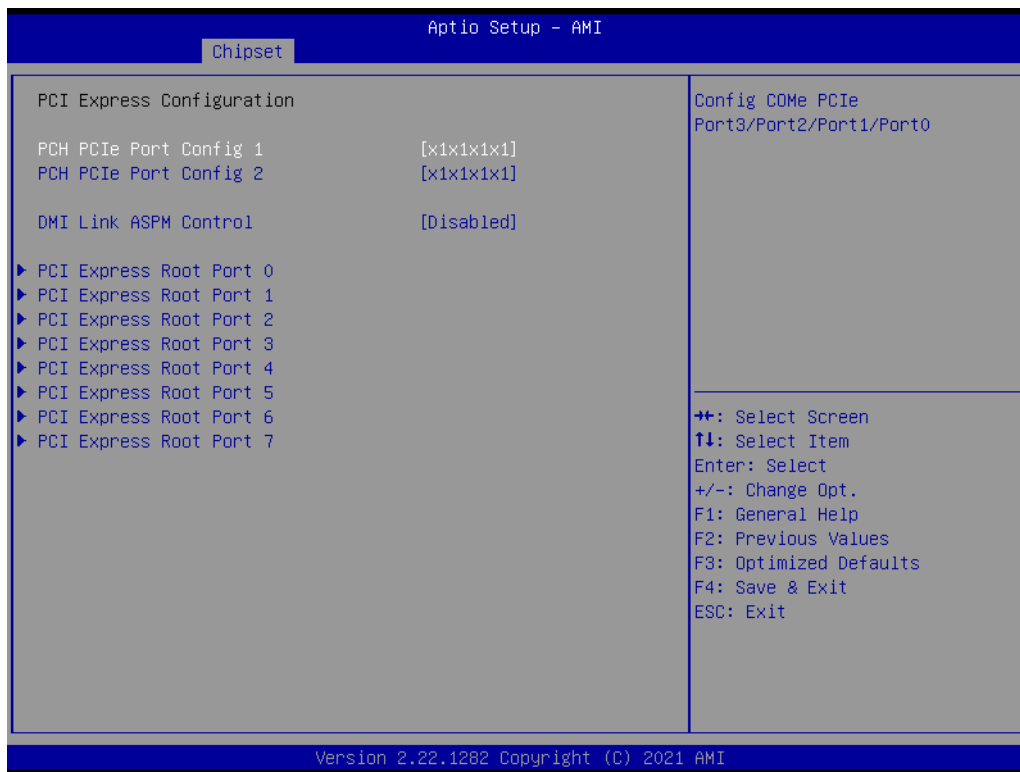

Figure 3.39 PCI Express Configuration

- PCH PCIe Port Config 1**
Config COMe PCIe Port3/Port2/Port1/Port0.
- PCH PCIe Port Config 2**
Config COMe PCIe Port7/Port6/Port5/Port4.
- DMI Link ASPM Control**
The control of Active State Power Management of the DMI Link.
- PCI Express Root Port 0**
- PCI Express Root Port 1**
- PCI Express Root Port 2**
- PCI Express Root Port 3**
- PCI Express Root Port 4**
- PCI Express Root Port 5**
- PCI Express Root Port 6**
- PCI Express Root Port 7**

3.5.2.1.1 PCI EXPRESS ROOT PORT 0

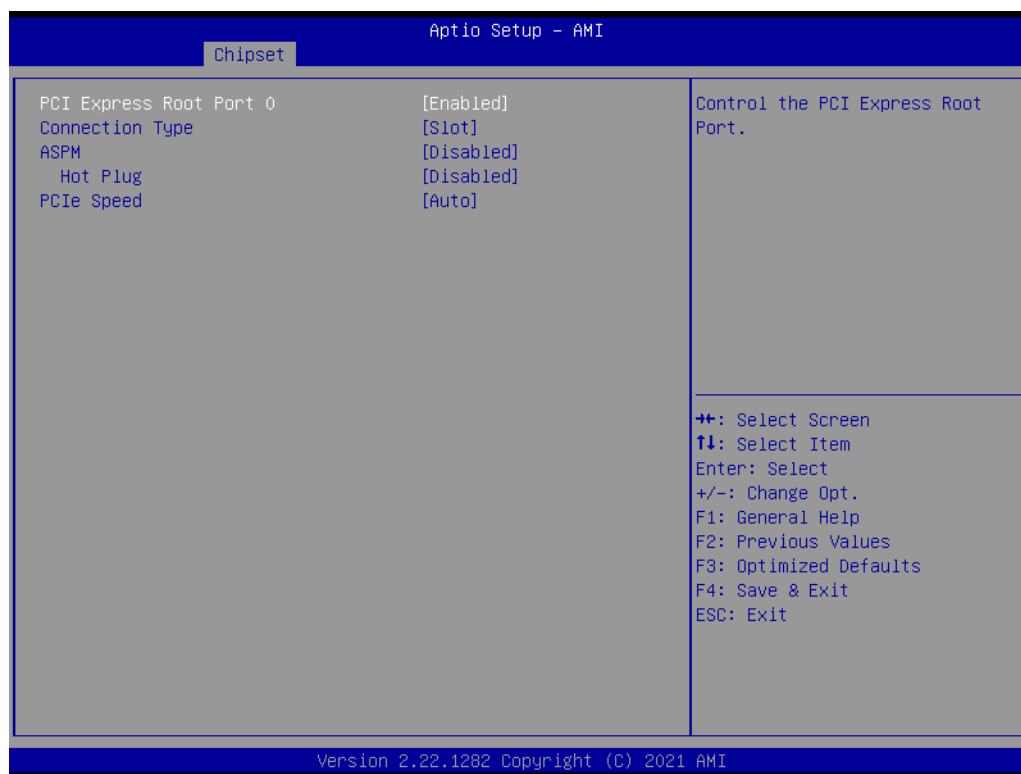

Figure 3.40 PCI Express Root Port 0

- PCI Express Root Port 0**
Control the PCI Express Root Port.
- Connection Type**
Built-In: a built-in device is connected to this root port. Slot Implemented bit will be clear.
Slot: this root port connects to user-accessible slot. Slot Implemented bit will be set.
- ASPM**
PCI Express Active State Power Management settings.
- Hot plug**
PCI Express hot plug enable/disable.
- PCIe Speed**
Configure PCIe Speed.

3.5.2.2 SATA CONFIGURATION

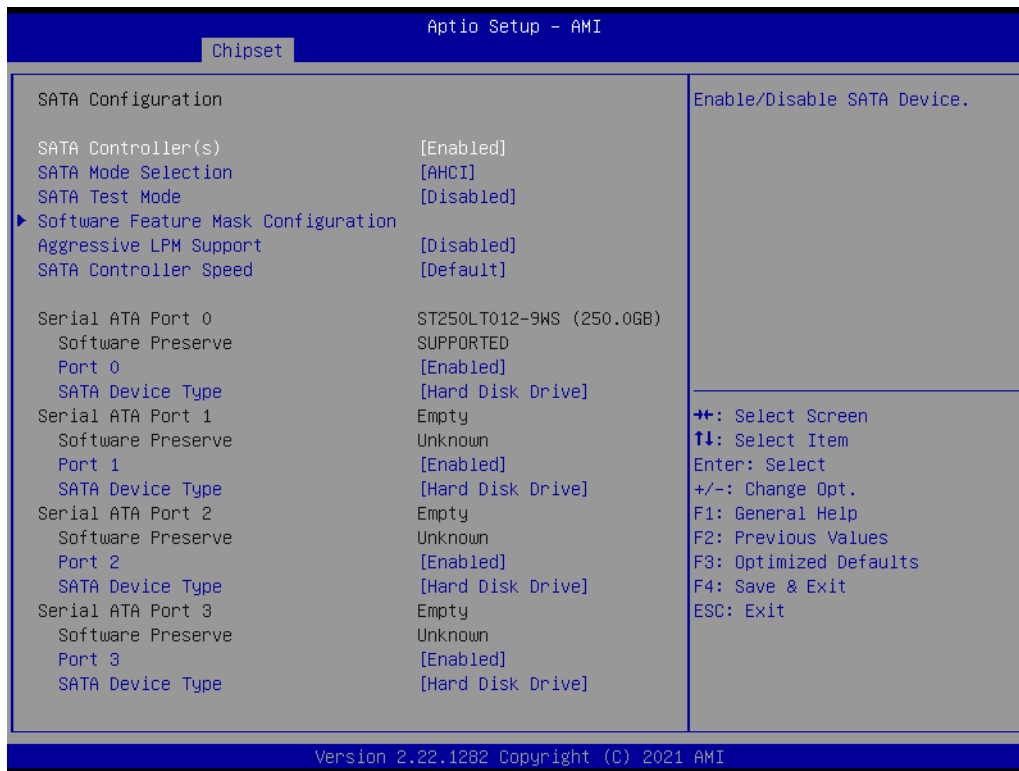

Figure 3.41 SATA Drives

- ❑ **SATA Controller(s)**
Enable/Disable SATA Device.
- ❑ **SATA Mode Selection**
Determines how SATA controller(s) operate.
- ❑ **SATA Test Mode**
Test Mode Enable/Disable (Loop Back).
- ❑ **Software Feature Mask Configuration**
RST Legacy OROM/RST UEFI driver will refer to the SWFM configuration to enable/disable the storage features.
- ❑ **Aggressive LPM Support**
Enable PCH to aggressively enter link power state.
- ❑ **SATA Controller Speed**
Indicates the maximum speed the SATA controller can support.
- ❑ **Port 0**
Enable or Disable SATA Port.
- ❑ **SATA Device Type**
Identify the SATA port is connected to Solid State Drive or Hard Disk Drive.

3.5.2.3 USB CONFIGURATION

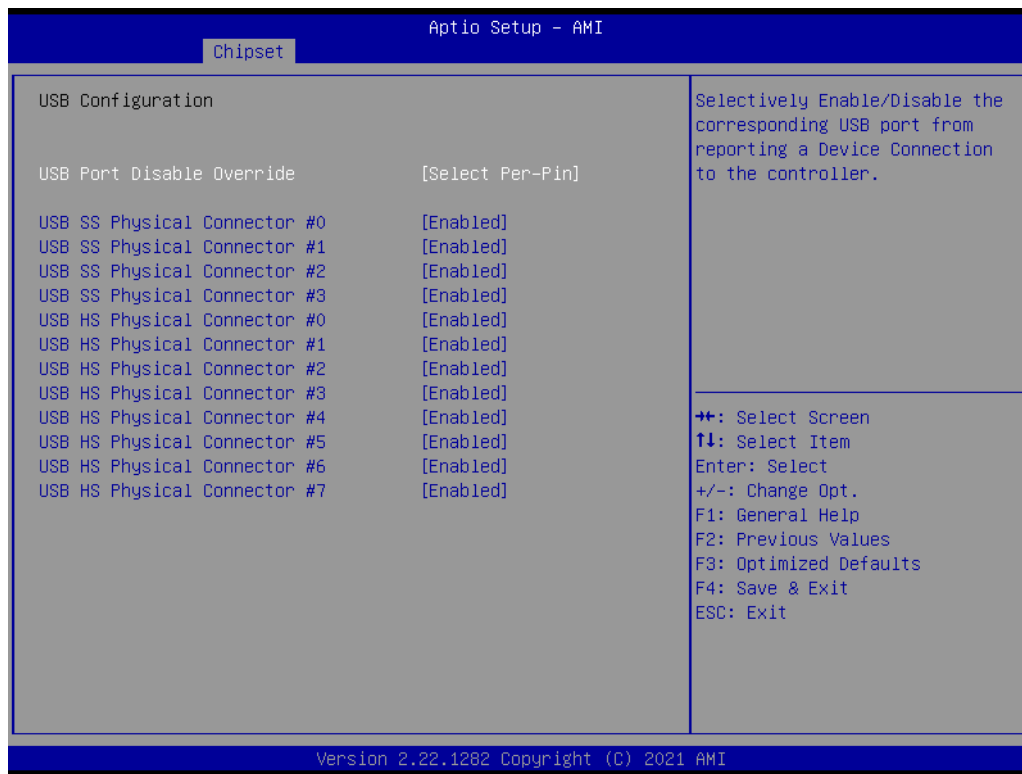

Figure 3.42 USB Configuration

- ❑ **USB Port Disable Override**
Selectively Enable/Disable the corresponding USB port from reporting a Device Connection to the controller.
- ❑ **USB SS Physical Connector #0**
Enable/Disable this USB Physical Connector (physical port). Once disabled, any USB devices plug into the connector will not be detected by BIOS or OS.

3.5.2.4 SECURITY CONFIGURATION



Figure 3.43 Security Configuration

- ❑ **RTC Memory Lock**
Enable will lock bytes 38h-3Fh in the lower/upper 126 –byte bank of RTC RAM.
- ❑ **BIOS Lock**
Enable/Disable the PCH BIOS lock enable feature. Required to be enabled to ensure SMM protection of flash

3.5.2.5 HD AUDIO SUBSYSTEM CONFIGURATION SETTINGS

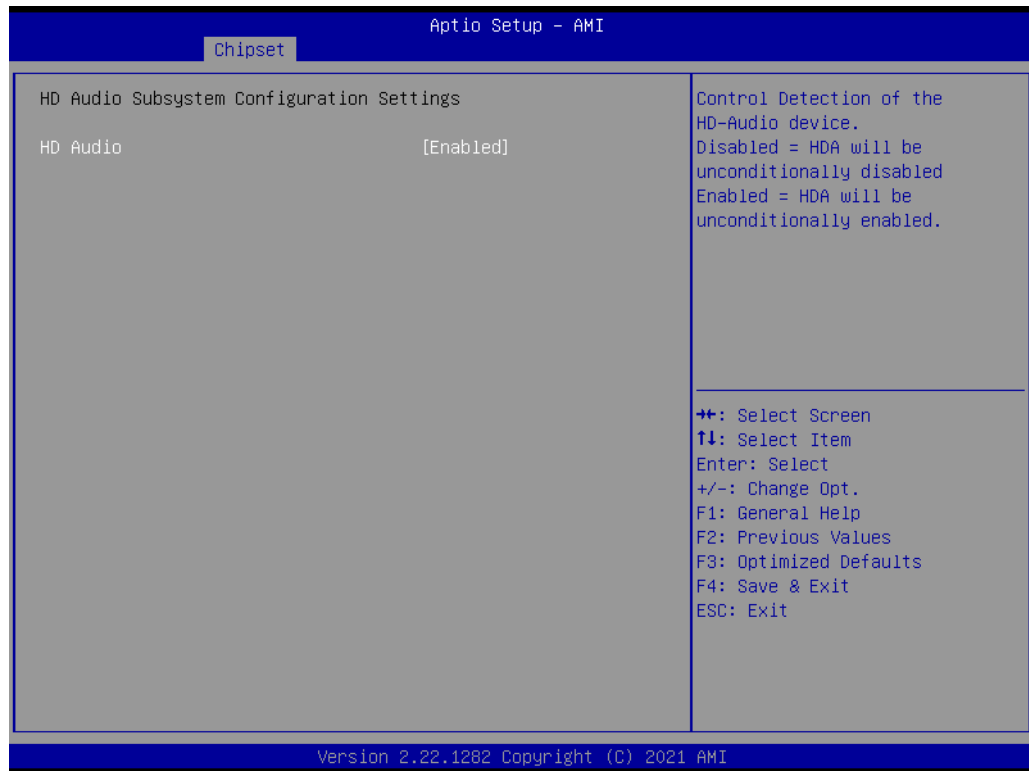

Figure 3.44 HD Audio Subsystem Configuration Settings

- **HD Audio**
Control Detection of the HD-Audio device. Disabled=HDA will be unconditionally disabled. Enabled=HDA will be unconditionally enabled.

3.5.2.6 SERIALIO CONFIGURATION

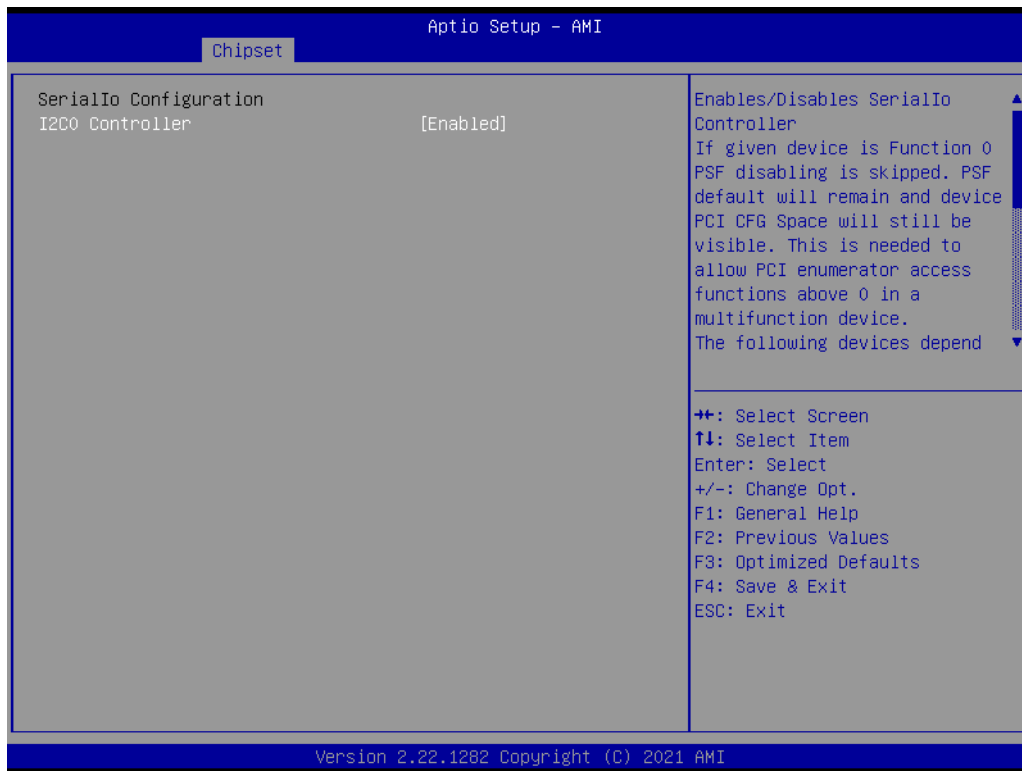

Figure 3.45 SerialIo Configuration

- ❑ **I2C0 Controller**
- ❑ **Enables/Disables SerialIo Controller.**

If given device is Function 0 PSF disabling is skipped. PSF default will remain and device PCI CFG Space will still be visible. This is needed to allow PCI enumerator access functions above 0 in a multifunction device.

The following devices depend on each other:

I2C0 and I2C1,2,3

UART0 and UART1,SPI0,1 UART2 and I2C4,5

UART 0 (00:30:00) cannot be disabled when:

1. Child device is enabled like CNVi Bluetooth (_SB.PC00.UA00.BTH0) UART 0 (00:30:00)

cannot be enabled when:

1. I2S Audio codec is enabled (_SB.PC00.I2C0.HDAC)

3.6 SECURITY CHIPSET



Figure 3.46 Security Chipset

- Administrator Password**
Set Setup Administrator Password.
- User Password**
Set User Password.
- Secure Boot**
Secure Boot Configuration.

3.6.1 SECURE BOOT



Figure 3.47 Secure Boot

- ❑ **Secure Boot**
Secure Boot feature is Active if Secure Boot is Enabled, Platform Key(PK) is enrolled and the System is in User mode. The mode change requires platform reset.
- ❑ **Secure Boot Mode**
Secure Boot mode options:
- ❑ **Standard or Custom.**
In Custom mode, Secure Boot Policy variables can be configured by a physically present user without full authentication.

3.6.2 BOOT SETUP

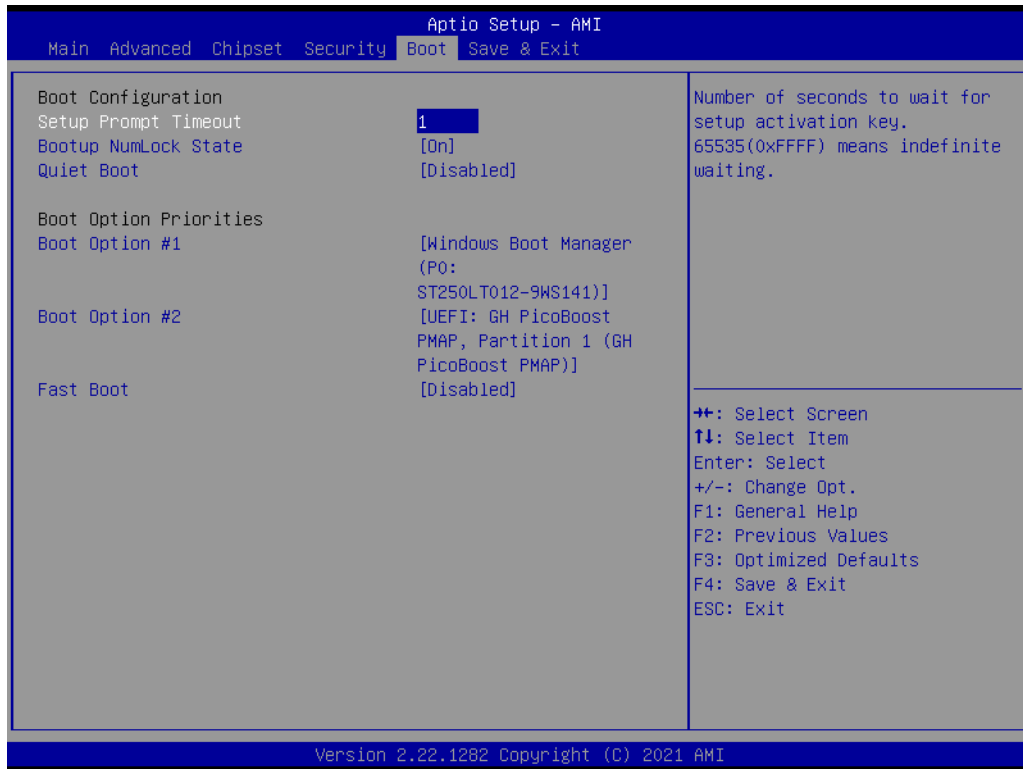

Figure 3.48 Boot Setup

- Setup Prompt Timeout**
Number of seconds to wait for setup activation key. 65535(0xFFFF) means indefinite waiting.
- Bootup NumLock State**
Select the keyboard NumLock state.
- Quiet Boot**
Enables or disables Quiet Boot option.
- Boot Option #1**
Sets the system boot order.
- Fast Boot**
Enable or Disable FastBoot features. Most probes are skipped to reduce time cost during boot.

3.7 SAVE & EXIT

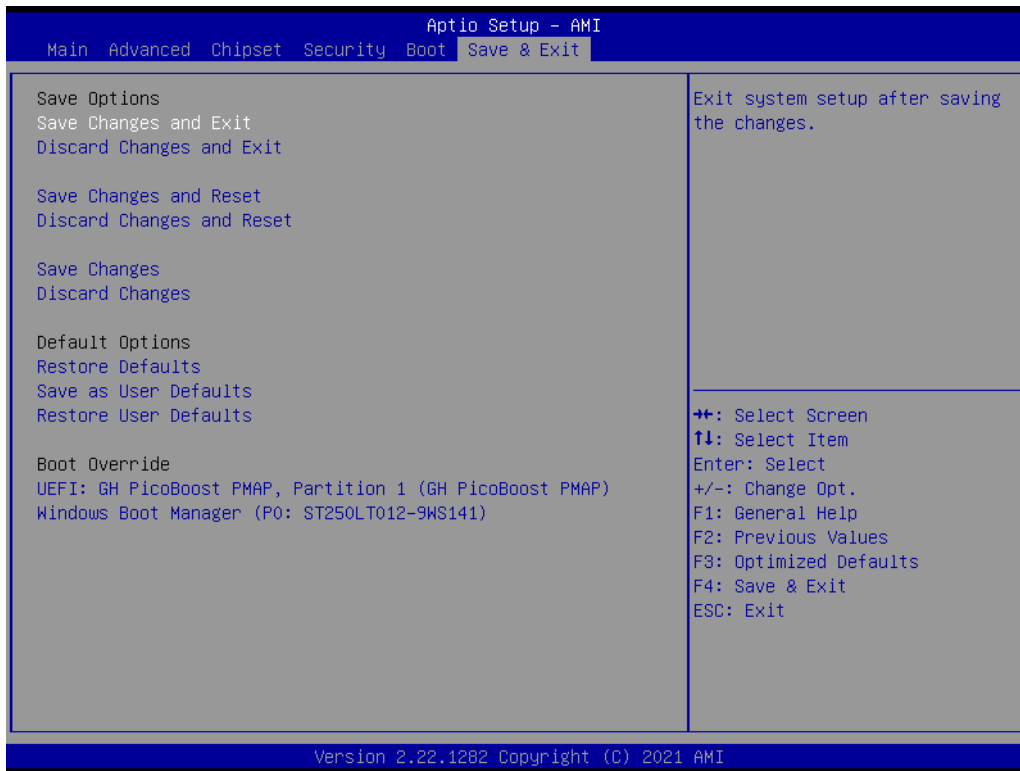

Figure 3.49 Save & Exit

- Save Changes and Exit**
Exit system setup after saving the changes.
- Discard Changes and Exit**
Exit system setup without saving any changes.
- Save Changes and Reset**
Reset the system after saving the changes.
- Discard Changes and Reset**
Reset system setup without saving any changes.
- Save Changes**
Save Changes done so far to any of the setup options.
- Discard Changes**
(005B) Discard Changes done so far to any of the setup options.
- Restore Defaults**
Restore/Load Default values for all the setup options.
- Save as User Defaults**
Save the changes done so far as User Defaults.
- Restore User Defaults**
Restore the User Defaults to all the setup options.
- Boot Override**

THOR200-X11EHG2 User's Manual

Revision Date: May. 31. 2023

This page intentionally left blank.